

Panasonic®

Administrator Guide

Smart Desk Phone

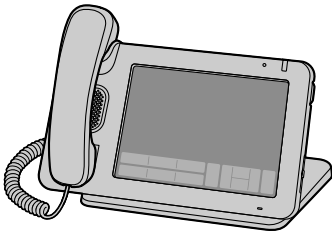

Model No. **KX-UT670**



Thank you for purchasing this Panasonic product.
Please read this manual carefully before using this product and save this manual for future use.

KX-UT670: Software File Version 01.070 or later

In this manual, the suffix of each model number is omitted unless necessary.

Document Version: 2012-07

Introduction

This Administrator Guide provides detailed information on the configuration and management of this unit. Technical descriptions are included in this guide. Prior knowledge of networking and VoIP (Voice over Internet Protocol) is required.

Related Documentation

Getting Started



Briefly describes basic information about the installation of the unit.

Operating Instructions

Describes the parts of the unit, operation procedures, maintenance, etc.

Manuals and supporting information are provided on the Panasonic Web site at:
<https://panasonic.net/cns/pcc/support/sipphone/>

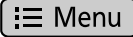
NOTES

- The screen shots shown in this guide are provided for reference only, and may differ from the screens displayed on your PC.
- SD Memory Cards that can be used with this unit are collectively referred to as "SD cards". For details about supported SD cards, refer to the appropriate Web site above.
- In this manual, buttons on the unit's key sheet are shown as . Depending on the country/area, the key sheet buttons on your unit will have only an icon (). Other text that appears on the screen is enclosed in square brackets and is shown in a bold typeface: **[Text]**.

Trademarks

- SDXC Logo is a trademark of SD-3C, LLC.
- Microsoft, Internet Explorer, and Windows are either registered trademarks or trademarks of Microsoft Corporation in the United States and/or other countries.
- Linux is a registered trademark of Linus Torvalds in the United States, other countries, or both.
- All other trademarks identified herein are the property of their respective owners.
- Microsoft product screen shot(s) reprinted with permission from Microsoft Corporation.

Table of Contents

1	Initial Setup	15
1.1	Setup	16
1.1.1	Factory Defaults	16
1.1.2	Language Selection for the Unit	16
1.1.3	Basic Network Setup	16
1.1.4	Other Network Settings	18
1.1.4.1	Firewall and Router Setup	18
1.1.4.2	NAT (Network Address Translation) Setup	19
1.1.4.3	Global Address Detection	20
2	General Information on Programming	21
2.1	Overview of Programming	22
2.2	Phone User Interface Programming	22
2.2.1	Changing the Language for Phone User Interface Programming	22
2.3	Web User Interface Programming	23
2.4	Configuration File Programming	24
2.4.1	Configuration File Programming Methods	25
2.4.2	Pre-provisioning	25
2.4.2.1	What is Pre-provisioning?	25
2.4.2.2	Server for Pre-provisioning	25
2.4.2.3	Pre-provisioning Setting Example	26
2.4.3	Provisioning	27
2.4.3.1	What is Provisioning?	27
2.4.3.2	Protocols for Provisioning	27
2.4.3.3	Configuration File	27
2.4.3.4	Downloading Configuration Files	28
2.4.3.5	Provisioning Server Setting Example	31
2.4.3.6	Encryption	32
2.4.4	XML Provisioning	32
2.4.4.1	XML Structure	33
2.4.4.2	XML Element/Attribute Configuration Parameter Table	35
2.4.4.3	Editing XML Configuration Files on your PC	45
2.4.5	Loading Settings Using the SD card	45
2.5	Priority of Setting Methods	46
3	Phone User Interface Programming	47
3.1	Phone User Interface Programming	48
3.1.1	Direct Commands	48
3.1.1.1	Terminal Number Settings	48
3.1.1.2	Reset Web ID/Password	48
3.1.2	Phone User Interface Administrator Menu	49
4	Web User Interface Programming	51
4.1	Web User Interface Setting List	52
4.2	General Information on Web User Interface Programming	61
4.2.1	Password for Web User Interface Programming	61
4.2.2	Changing the Language for Web User Interface Programming	61
4.2.3	Before Accessing the Web User Interface	61
4.2.4	Accessing the Web User Interface	63
4.3	Status	66
4.3.1	Version Information	66
4.3.1.1	Version Information	66

Table of Contents

	Model	66
	Firmware Version	66
4.3.2	Network Status	66
4.3.2.1	Network Status	67
	MAC Address	67
	Ethernet Link Status (LAN Port)	67
	Ethernet Link Status (PC Port)	67
	Connection Mode	67
	IP Address	67
	Subnet Mask	67
	Default Gateway	68
	DNS1	68
	DNS2	68
4.3.3	VoIP Status	68
4.3.3.1	VoIP Status	69
	Line No.	69
	Phone Number	69
	VoIP Status	69
4.4	Network	69
4.4.1	Basic Network Settings	69
4.4.1.1	Connection Mode	70
	Connection Mode	70
4.4.1.2	DHCP Settings	70
	Host Name	70
	Domain Name Server	71
4.4.1.3	Static Settings	71
	Static IP Address	71
	Subnet Mask	72
	Default Gateway	72
	DNS1	72
	DNS2	72
4.4.2	Ethernet Port Settings	73
4.4.2.1	Link Speed/Duplex Mode	73
	LAN Port	73
	PC Port	74
4.4.2.2	LLDP Settings	74
	LLDP	74
	LLDP-MED Interval timer	74
	PC (VLAN ID)	75
	PC (Priority)	75
4.4.2.3	VLAN Settings	75
	Enable VLAN	75
	IP Phone (VLAN ID)	75
	IP Phone (Priority)	76
	PC (VLAN ID)	76
	PC (Priority)	76
4.4.3	HTTP Client Settings	77
4.4.3.1	HTTP Client Settings	77
	HTTP Version	77
	HTTP User Agent	77
4.4.3.2	HTTP Authentication	78
	Authentication ID	78
	Authentication Password	78
4.4.3.3	Proxy Server Settings	78
	Enable Proxy	78

	Proxy Server Address	79
	Proxy Server Port	79
4.4.4	Global Address Detection	79
4.4.4.1	Global Address Detection	79
	Detection Method	79
	Detection Interval	80
4.4.4.2	STUN Server	80
	STUN Server Address	80
	STUN Server Port	80
4.4.5	Static NAPT Settings	80
4.4.5.1	Global IP Address	81
	Global IP Address	81
4.4.5.2	Enable Global IP Address Usage per Line	81
	Line 1–Line 6	81
4.4.5.3	External RTP Port	82
	Channel 1–25	82
4.5	System	82
4.5.1	Web Language	82
4.5.1.1	Web Language	83
	Language	83
4.5.2	Administrator Password	83
4.5.2.1	Change Administrator Password	84
	Current Password	84
	New Password	84
	Confirm New Password	84
4.5.3	Change User Password	85
4.5.3.1	Change User Password	85
	Current Password	85
	New Password	85
	Confirm New Password	86
4.5.4	Web Server Settings	86
4.5.4.1	Web Server Settings	86
	Web Server Port	86
	Port Close Timer	87
4.6	VoIP	87
4.6.1	SIP Settings	87
4.6.1.1	SIP Setting	88
	SIP User Agent	88
4.6.2	SIP Settings [Line 1]–[Line 6]	88
4.6.2.1	Phone Number	89
	Phone Number	89
	SIP URI	89
4.6.2.2	SIP Server	89
	Registrar Server Address	89
	Registrar Server Port	89
	Proxy Server Address	90
	Proxy Server Port	90
	Presence Server Address	90
	Presence Server Port	90
4.6.2.3	Outbound Proxy Server	91
	Outbound Proxy Server Address	91
	Outbound Proxy Server Port	91
4.6.2.4	SIP Service Domain	91
	Service Domain	91
4.6.2.5	SIP Source Port	91

Table of Contents

	Source Port	91
4.6.2.6	SIP Authentication	92
	Authentication ID	92
	Authentication Password	92
4.6.2.7	DNS	92
	Enable DNS SRV lookup	92
	SRV lookup Prefix for UDP	93
	SRV lookup Prefix for TCP	93
4.6.2.8	Transport Protocol for SIP	93
	Transport Protocol	93
4.6.2.9	Timer Settings	94
	T1 Timer	94
	T2 Timer	94
	Timer B	94
	Timer D	95
	Timer F	95
	Timer H	95
	Timer J	95
4.6.2.10	Quality of Service (QoS)	95
	SIP Packet QoS (DSCP)	95
4.6.2.11	SIP extensions	96
	Supports 100rel (RFC 3262)	96
	Supports Session Timer (RFC 4028)	96
4.6.2.12	NAT Identity	96
	Keep Alive Interval	96
	Supports Rport (RFC 3581)	97
4.6.2.13	Security	97
	Enable SSAF (SIP Source Address Filter)	97
4.6.3	VoIP Settings	98
4.6.3.1	RTP Settings	98
	RTP Packet Time	98
	Minimum RTP Port Number	98
	Maximum RTP Port Number	99
	Telephone-event Payload Type	99
4.6.4	VoIP Settings [Line 1]–[Line 6]	100
4.6.4.1	Quality of Service (QoS)	100
	RTP Packet QoS (DSCP)	100
	RTCP Packet QoS (DSCP)	100
4.6.4.2	Statistical Information	101
	RTCP Enable	101
	RTCP Interval	101
4.6.4.3	Jitter Buffer	101
	Maximum Delay	101
	Minimum Delay	101
	Initial Delay	102
4.6.4.4	DTMF	102
	DTMF Type	102
	DTMF Relay	102
4.6.4.5	Call Hold	103
	Supports RFC 2543 (c=0.0.0.0)	103
4.6.4.6	CODEC Preferences	103
	G722 (Enable)	103
	G722 (Priority)	103
	PCMA (Enable)	104
	PCMA (Priority)	104

	G729A (Enable)	104
	G729A (Priority)	104
	PCMU (Enable)	104
	PCMU (Priority)	105
4.7	Telephone	105
4.7.1	Call Control	105
4.7.1.1	Call Control	105
	Send SUBSCRIBE to Voice Mail Server	105
	Conference Server URI	106
	Inter-digit Timeout	106
	Timer for Dial Plan	106
	International Call Prefix	106
	Country Calling Code	107
	National Access Code	107
	Default Line for Outgoing	107
	Flash/Recall Button	107
	Flash Hook Event	108
	Directed Call Pickup	108
4.7.1.2	Call Rejection Phone Numbers	108
	1–30	108
4.7.2	Call Control [Line 1]–[Line 6]	109
4.7.2.1	Call Control	109
	Display Name	109
	Voice Mail Access Number	109
	Enable Shared Call	110
	Synchronize Do Not Disturb and Call Forward	110
	Resource List URI	111
4.7.2.2	Dial Plan	111
	Dial Plan (max 500 columns)	111
	Call Even If Dial Plan Does Not Match	111
4.7.2.3	Call Features	112
	Block Caller ID	112
	Block Anonymous Call	112
	Do Not Disturb	113
4.7.2.4	Call Forward	113
	Unconditional (Enable Call Forward)	113
	Unconditional (Phone Number)	114
	Busy (Enable Call Forward)	114
	Busy (Phone Number)	115
	No Answer (Enable Call Forward)	115
	No Answer (Phone Number)	116
	No Answer (Ring Count)	116
4.7.3	Tone Settings	117
4.7.3.1	Dial Tone	117
	Tone Frequencies	117
	Tone Timings	117
4.7.3.2	Busy Tone	118
	Tone Frequencies	118
	Tone Timings	118
4.7.3.3	Ringtone	118
	Tone Frequencies	118
	Tone Timings	119
4.7.3.4	Stutter Tone	119
	Tone Frequencies	119
	Tone Timings	119

4.7.3.5	Reorder Tone	120
	Tone Frequencies	120
	Tone Timings	120
4.7.4	Telephone Settings	120
4.7.4.1	Telephone Settings	120
	Number Matching Lower Digit	120
	Number Matching Upper Digit	121
4.8	Maintenance	121
4.8.1	Firmware Maintenance	121
4.8.1.1	Firmware Maintenance	121
	Enable Firmware Update	121
	Firmware File URL	122
4.8.2	Provisioning Maintenance	122
4.8.2.1	Provisioning Maintenance	123
	Enable Provisioning	123
	Standard File URL	123
	Product File URL	123
	Master File URL	124
	Cyclic Auto Resync	124
	Resync Interval	124
	Header Value for Resync Event	124
4.8.3	Reset to Defaults	125
4.8.4	Restart	125
4.9	Result Messages	126
5	Configuration File Programming	127
5.1	Configuration File Parameter List	128
5.2	General Information on the Configuration Files	135
5.2.1	Configuration File Specifications for Plain Text Provisioning	135
5.2.2	Configuration File Parameters	136
5.2.3	Characters Available for String Values	137
5.3	Configuration File Examples	137
5.3.1	Examples of Codec Settings	138
5.3.2	Example with Incorrect Descriptions	138
5.4	System Settings	140
5.4.1	Login Account Settings	140
	ADMIN_ID	140
	ADMIN_PASS	140
	USER_ID	140
	USER_PASS	140
5.4.2	System Time Settings	141
	TIME_ZONE_COUNTRY	141
5.4.3	Syslog Settings	143
	SYSLOG_ADDR	143
	SYSLOG_PORT	143
5.4.4	Firmware Update Settings	143
	FIRM_UPGRADE_ENABLE	143
	FIRM_VERSION	143
	FIRM_FILE_PATH	144
5.4.5	Provisioning Settings	144
	OPTION66_ENABLE	144
	PROVISION_ENABLE	145
	CFG_STANDARD_FILE_PATH	145
	CFG_PRODUCT_FILE_PATH	146
	CFG_MASTER_FILE_PATH	147

	CFG_FILE_KEY1	148
	CFG_FILE_KEY2	149
	CFG_FILE_KEY3	149
	CFG_FILE_KEY_LENGTH	149
	CFG_CYCLIC	149
	CFG_CYCLIC_INTVL	150
	CFG_RTRY_INTVL	150
	CFG_RESYNC_TIME	150
	CFG_RESYNC_FROM_SIP	151
5.5	Network Settings	151
5.5.1	Ethernet Port Settings	151
	LLDP_ENABLE	151
	LLDP_INTERVAL	152
	LLDP_VLAN_ID_PC	152
	LLDP_VLAN_PRI_PC	152
	VLAN_ENABLE	152
	VLAN_ID_IP_PHONE	153
	VLAN_PRI_IP_PHONE	153
	VLAN_ID_PC	154
	VLAN_PRI_PC	154
5.5.2	HTTP Settings	154
	HTTPD_PORTOPEN_AUTO	154
	HTTP_VER	155
	HTTP_USER_AGENT	155
	HTTP_SSL_VERIFY	156
	CFG_ROOT_CERTIFICATE_PATH	156
5.5.3	Time Adjust Settings	157
	NTP_ADDR	157
	TIME_SYNC_INTVL	157
	TIME_QUERY_INTVL	157
5.5.4	STUN Settings	157
	STUN_SERV_ADDR	157
	STUN_SERV_PORT	158
	STUN_2NDSERV_ADDR	158
	STUN_2NDSERV_PORT	158
5.5.5	Miscellaneous Network Settings	158
	NW_SETTING_ENABLE	158
	CUSTOM_WEB_PAGE	159
5.6	Telephone Settings	159
5.6.1	Call Control Settings	159
	VM_SUBSCRIBE_ENABLE	159
	CONFERENCE_SERVER_URI	160
	FIRSTDIGIT_TIM	160
	INTDIGIT_TIM	160
	MACRODIGIT_TIM	160
	INTERNATIONAL_ACCESS_CODE	161
	COUNTRY_CALLING_CODE	161
	NATIONAL_ACCESS_CODE	161
	DEFAULT_LINE_SELECT	161
	DATA_LINE_MODE	162
	NUM_PLAN_PICKUP_DIRECT	162
	TALK_PACKAGE	162
	HOLD_PACKAGE	162
	HOLD_RECALL_TIM	163
	AUTO_ANS_RING_TIM	163

	RINGING_OFF_SETTING_ENABLE	163
	AUTO_CALL_HOLD	163
	REDIALKEY_CALLLOG_ENABLE	164
	ONHOOK_TRANSFER_ENABLE	164
	DISCONNECTION_MODE	164
	TONE_LEN_DISCONNECT_HANDSET	164
	TONE_LEN_DISCONNECT_HANDSFREE	165
	KEY_PAD_TONE	165
	DDI_ICD_GROUP_DISPLAY	165
5.6.2	Tone Settings	166
	DIAL_TONE1_FRQ	166
	DIAL_TONE1_GAIN	166
	DIAL_TONE1_TIMING	166
	DIAL_TONE2_FRQ	166
	DIAL_TONE2_GAIN	167
	DIAL_TONE2_TIMING	167
	DIAL_TONE4_FRQ	167
	DIAL_TONE4_GAIN	167
	DIAL_TONE4_TIMING	167
	BUSY_TONE_FRQ	168
	BUSY_TONE_GAIN	168
	BUSY_TONE_TIMING	168
	REORDER_TONE_FRQ	169
	REORDER_TONE_GAIN	169
	REORDER_TONE_TIMING	169
	RINGBACK_TONE_FRQ	169
	RINGBACK_TONE_GAIN	170
	RINGBACK_TONE_TIMING	170
	HOLD_ALARM_FRQ	170
	HOLD_ALARM_GAIN	170
	HOLD_ALARM_TIMING	170
	CW_TONE1_FRQ	171
	CW_TONE1_GAIN	171
	CW_TONE1_TIMING	171
	HOLD_TONE_FRQ	171
	HOLD_TONE_GAIN	171
	HOLD_TONE_TIMING	172
5.6.3	Telephone Settings	172
	DISPLAY_NAME_REPLACE	172
	NUMBER_MATCHING_LOWER_DIGIT	172
	NUMBER_MATCHING_UPPER_DIGIT	172
	DISPLAY_DATE_PATTERN	173
	DISPLAY_TIME_PATTERN	173
	DEFAULT_LANGUAGE	173
	POUND_KEY_DELIMITER_ENABLE	174
	WALLPAPER_URI_HOME	174
	WALLPAPER_URI_PHONE	174
	LOGO_URI_PHONE	175
5.6.4	Flexible Button Settings	175
	FLEX_BUTTON_FACILITY_ACTx	175
	FLEX_BUTTON_FACILITY_ARGx	175
	FLEX_BUTTON_LABELx	176
5.7	VoIP Settings	176
5.7.1	Codec Settings	176
	CODEC_G711_REQ	176

	CODEC_G729_PARAM	177
	CODEC_ENABLEx_n	177
	CODEC_PRIORITYx_n	177
5.7.2	RTP Settings	178
	DSCP_RTP_n	178
	DSCP_RTCP_n	178
	RTCP_INTVL_n	179
	MAX_DELAY_n	179
	MIN_DELAY_n	179
	NOM_DELAY_n	180
	RTP_PORT_MIN	180
	RTP_PORT_MAX	180
	RTP_PTIME	181
	RTCP_ENABLE_n	181
	RTCP_SEND_BY_SDP_n	182
	RTP_CLOSE_ENABLE_n	182
5.7.3	Miscellaneous VoIP Settings	182
	OUTBANDDTMF_n	182
	DTMF_RELAY_n	183
	TELEVENT_PAYLOAD	183
	RFC2543_HOLD_ENABLE_n	183
	DTMF_SIGNAL_LEN	184
	DTMF_INTDIGIT_TIM	184
5.8	Line Settings	184
5.8.1	Call Control Settings	184
	DISPLAY_NAME_n	184
	VM_NUMBER_n	184
	DIAL_PLAN_n	185
	DIAL_PLAN_NOT_MATCH_ENABLE_n	185
	SHARED_CALL_ENABLE_n	186
	FWD_DND_SYNCHRO_ENABLE_n	186
	RESOURCELIST_URI_n	187
	CW_ENABLE_n	187
	FLASH_RECALL_TERMINATE	187
	FLASHHOOK_CONTENT_TYPE	188
	VOICE_MESSAGE_AVAILABLE	188
5.8.2	SIP Settings	188
	SIP_USER_AGENT	188
	PHONE_NUMBER_n	189
	SIP_URI_n	189
	LINE_ENABLE_n	189
	PROFILE_ENABLE_n	190
	SIP_AUTHID_n	190
	SIP_PASS_n	190
	SIP_SRC_PORT_n	191
	SIP_PRXY_ADDR_n	191
	SIP_PRXY_PORT_n	191
	SIP_RGSTR_ADDR_n	191
	SIP_RGSTR_PORT_n	192
	SIP_SVCDOMAIN_n	192
	REG_EXPIRE_TIME_n	192
	REG_INTERVAL_RATE_n	193
	SIP_SESSION_TIME_n	193
	SIP_SESSION_METHOD_n	193
	DSCP_SIP_n	193

Table of Contents

SIP_2NDPROXY_ADDR_n	194
SIP_2NDPROXY_PORT_n	194
SIP_2NDRGSTR_ADDR_n	194
SIP_2NDRGSTR_PORT_n	195
SIP_TIMER_T1_n	195
SIP_TIMER_T2_n	195
SIP_TIMER_T4_n	196
SIP_FOVR_NORSP_n	196
SIP_FOVR_MAX_n	196
SIP_REFRESHER_n	197
SIP_DNSSRV_ENA_n	197
SIP_UDP_SRV_PREFIX_n	197
SIP_TCP_SRV_PREFIX_n	198
SIP_100REL_ENABLE_n	198
SIP_INVITE_EXPIRE_n	198
SIP_18X_RTX_INTVL_n	199
SIP_PR SNC_ADDR_n	199
SIP_PR SNC_PORT_n	199
SIP_2NDPR SNC_ADDR_n	200
SIP_2NDPR SNC_PORT_n	200
USE_DEL_REG_OPEN_n	200
USE_DEL_REG_CLOSE_n	200
PORT_PUNCH_INTVL_n	201
SIP_ADD_RPORT_n	201
SIP_REQUIR_PORT_n	201
SIP_SUBS_EXPIRE_n	202
SUB_RTX_INTVL_n	202
REG_RTX_INTVL_n	203
SIP_P_PREFERRED_ID_n	203
SIP_PRIVACY_n	203
ADD_USER_PHONE_n	203
SDP_USER_ID_n	204
SUB_INTERVAL_RATE_n	204
SIP_OUTPROXY_ADDR_n	204
SIP_OUTPROXY_PORT_n	205
SIP_TRANSPORT_n	205
SIP_ANM_DISPNAME_n	205
SIP_ANM_USERNAME_n	205
SIP_ANM_HOSTNAME_n	206
SIP_DETECT_SSAF_n	206
SIP_RCV_DET_HEADER_n	206
SIP_CONTACT_ON_ACK_n	207
SIP_TIMER_B_n	207
SIP_TIMER_D_n	207
SIP_TIMER_F_n	208
SIP_TIMER_H_n	208
SIP_TIMER_J_n	208
ADD_TRANSPORT_UDP_n	208
ADD_EXPIRES_HEADER_n	209
SIP_HOLD_HOLDRECEIVE_n	209
SIP_ADD_DIVERSION_n	209
SIP_RESPONSE_CODE_DND	210
SIP_RESPONSE_CODE_CALL_REJECT	210

6 Useful Telephone Functions211

6.1	Registering One-touch Buttons and BLF Buttons	212
6.2	Setting the Feature Number to Access Voice Mail	212
6.3	Registering Flexible Buttons	212
6.4	Customizing the Phone	212
6.5	Adding Applications	213
6.6	Dial Plan	214
6.6.1	Dial Plan Settings	215
7	Firmware Update	219
7.1	General Information on Firmware Update	220
7.2	Firmware Update Settings	220
7.3	Executing Firmware Update	221
7.4	Firmware Update Using the SD Card	222
8	Backup and Restore	223
8.1	Backup and Restore	224
9	Resetting the Unit	227
9.1	Resetting to Factory Default and Clearing Data/Settings	228
9.2	Resetting the Settings Made through the Web User Interface (Reset Web Settings)	228
10	Troubleshooting	231
10.1	Troubleshooting	232
11	Open Source Software	237
11.1	License Information	238
12	Appendix	239
12.1	Revision History	240
12.1.1	Software File Version 01.030	240
12.1.2	Software File Version 01.070	241
	Index.....	243

Section 1

Initial Setup

This section provides an overview of the setup procedures for the unit.

1.1 Setup

1.1.1 Factory Defaults

Many of the settings for this unit have been configured before the unit ships.

Where possible, these settings are configured with the optimum or most common values for the setting. For example, the port number of the SIP (Session Initiation Protocol) server is set to "5060".

However, many of the settings, such as the address of the SIP server or the phone number, have not been pre-configured, and they must be modified depending on the usage environment.

1.1.2 Language Selection for the Unit

You can change the language used on the display.

In addition, various settings can be configured by accessing the Web user interface from a PC on the same network. You can select the language for the Web user interface.

Note

- To select the display language for the unit, refer to the Operating Instructions on the Panasonic Web site (→ see **Introduction**).
- To select the display language for the Web user interface, see **4.5.1 Web Language**.

1.1.3 Basic Network Setup

This section describes the basic network settings that you must configure before you can use the unit on your network.

You must configure the following network settings:

- TCP/IP settings (DHCP [Dynamic Host Configuration Protocol] or static IP address assignment)
- DNS server settings
- Ethernet port settings (Ethernet port connection mode, LLDP settings or VLAN settings)
- NTP server settings

Network Settings

The following procedures explain how to change the network settings via the unit.

For details about the individual network settings that can be configured via the unit, refer to the Operating Instructions on the Panasonic Web site (→ see **Introduction**).

For details about configuring network settings via the Web user interface, see **4.4.1 Basic Network Settings**.

To obtain an IP address from a DHCP server

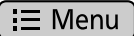
1. Press  on the Home screen, and then tap **[Settings]**.
2. Tap **[Network]** and then select **[Basic Network settings]**.
3. In **[Connection mode]**, select **[DHCP]**.
4. In **[DHCP Settings]**, select **[Receive DNS server address automatically]**.
5. Tap **[OK]**.

Note

- If you selected **[Use the following settings]** in step 4, enter the addresses for DNS1 (primary DNS server) and, if necessary, DNS2 (secondary DNS server) manually.

To use a static IP address

1. Press **[Menu]** on the Home screen, and then tap **[Settings]**.
2. Tap **[Network]** and then select **[Basic Network settings]**.
3. In **[Connection mode]**, select **[STATIC]**.
4. Enter the IP address.
5. Enter the subnet mask.
6. Enter the default gateway.
7. Enter the DNS1 (primary DNS server), and, if necessary, DNS2 (secondary DNS server).
8. Tap **[OK]**.

Note

- If your phone system dealer does not allow you these settings, you cannot change them even though the unit shows the setting menu. Contact your phone system dealer for further information.
- If you select **[DHCP]** for the connection mode, all the settings concerning static connection will be ignored, even if they have been specified.
- If you select **[DHCP]** for the connection mode, and enable **[Receive DNS server address automatically]**, the DNS server settings (DNS1 and DNS2) will be ignored, even if they have been specified.

Ethernet Settings

The following procedures explain how to change the Ethernet port connection mode (link speed/duplex mode), LLDP (Link Layer Discovery Protocol) settings and VLAN (Virtual Local Area Network) settings via the unit. For details about configuring Ethernet settings via the Web user interface, see **4.4.2 Ethernet Port Settings**.

Using LLDP

1. Press **[Menu]** on the Home screen, and then tap **[Settings]**.
2. Tap **[Administration]**, enter the administrator password, and then tap **[OK]**.
3. Tap **[Ethernet port settings]**.
4. Select the connection mode for **[LAN port]** and **[PC port]**.
5. Check **[Use LLDP]**.
6. Enter the LLDP-MED Timer.
7. Enter the VLAN ID.
8. Enter the priority.
9. Tap **[Save and Reboot]**.

Using VLAN

1. Press **[Menu]** on the Home screen, and then tap **[Settings]**.
2. Tap **[Administration]**, enter the administrator password, and then tap **[OK]**.
3. Tap **[Ethernet port settings]**.
4. Select the connection mode for **[LAN port]** and **[PC port]**.
5. Check **[Use VLAN]**.
6. Enter the VLAN ID.
7. Enter the priority.
8. Tap **[Save and Reboot]**.

Note

- For details about the administrator password, see **3.1.2 Phone User Interface Administrator Menu**.
- When both **[Use LLDP]** and **[Use VLAN]** are checked, VLAN settings are prioritized.

Date and Time (NTP Server) Settings

The following procedure explains how to set the date and time using a NTP (Network Time Protocol) server via the unit.

1. Press **[Menu]** on the Home screen, and then tap **[Settings]**.
2. Tap **[Date & time]** and then select **[NTP Server]**.
3. Check **[Use NTP server]**.
4. Enter the NTP server's address.
5. Enter the synchronization interval.
6. Tap **[OK]**.

Note

- If your phone system dealer does not allow you these settings, you cannot change them even though the unit shows the setting menu. Contact your phone system dealer for further information.

1.1.4 Other Network Settings

1.1.4.1 Firewall and Router Setup

When the unit is connected to a network that is protected by a firewall and/or router, you need to configure the firewall and/or router so that they do not block communication from the IP address and port number used by the unit.

1.1.4.2 NAT (Network Address Translation) Setup

This section provides information about configuring a router that uses NAT.

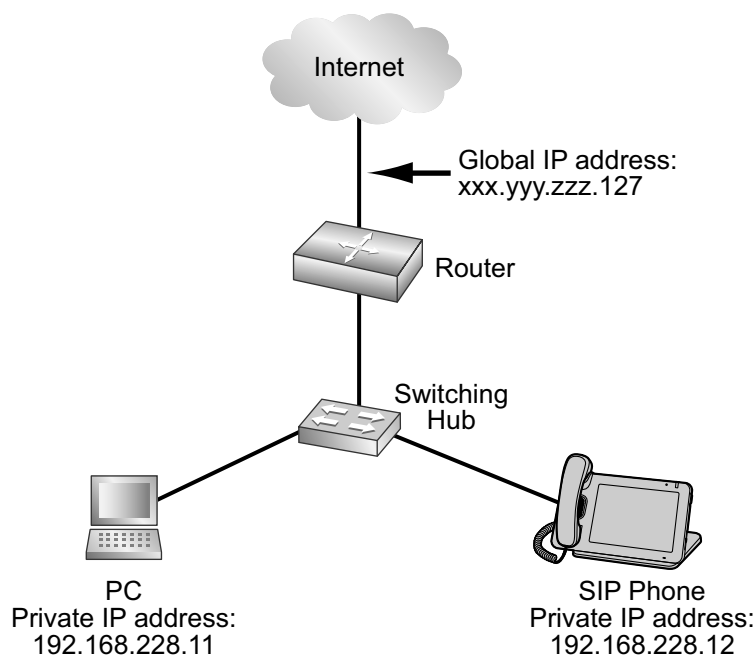

If the unit is connected to a network that uses a NAT router and a private IP address is assigned to each terminal on the network, depending on your phone system's setup, you might need to configure the unit and router so as to use NAT Traversal techniques.

If your phone system dealer provides an outbound proxy service that supports NAT Traversal, you need only to set the IP address of the SIP outbound proxy server to the unit—no other settings are necessary.

However, depending on the phone system of the outbound proxy service, no setting may be necessary because private IP addresses are automatically translated into global IP addresses by the outbound proxy server.

For details about the outbound proxy service, consult your phone system dealer.

When TCP is used to transport the SIP messages, you must always configure the devices for NAT Traversal.

To configure NAT Traversal, you must have the following information:

- The global IP address of the router.
- The port numbers you will specify for **[Source Port]** and **[External RTP Port]** through the Web user interface, so that you can configure the appropriate port forwarding settings.

Note

- Because the IP address of the router needs to be set in the unit, the IP address must be static.

SIP Setup

It might be necessary to manually set the router's global IP address and reception port number in the unit. In addition, it might also be necessary to configure the port forwarding settings of the router so that packets sent from an outside network are sent to the unit. These settings are required for each individual line. For details about Web user interface programming, see **4.4.5 Static NAPT Settings** and **4.6.2.5 SIP Source Port**.

RTP (Real-time Transport Protocol) Setup

If the unit is connected to a network that uses a NAT router and a private IP address is assigned to each terminal on the network, you must configure the RTP function for the unit and router so that the units can perform voice transmission between each other using a peer-to-peer connection.

However, if your phone system supports the SBC (Session Border Controller) function, it is not necessary to configure these settings.

For details about the SBC function, consult your phone system dealer.

For details about Web user interface programming, see **4.4.5 Static NAPT Settings**.

Router Setup

When configuring the port forwarding function, specify the router's reception port number as the unit's port number.

Port forwarding should be configured for the ports specified in **[Source Port]** (→ see **SIP Setup** in this section) and **[External RTP Port]** (→ see **RTP (Real-time Transport Protocol) Setup** in this section).

Set the same port number for the source port and destination port, and set the unit's private IP address as the destination address.

Because the unit's private IP address will have to be set in the router's port forwarding configuration again if it is changed, set a static IP address to the unit, or configure the router so that the same IP address is always assigned to the unit if IP addresses are assigned by a DHCP server.

For details about how to configure the router, refer to the documentation for the router.

Because the port forwarding settings depend on the user's network environment, they cannot be programmed using configuration files.

1.1.4.3 Global Address Detection

The global IP address is a unique IP address that is assigned to a particular terminal. If the global IP address assigned to the firewall or the router is changed, the unit will not be able to communicate.

If the global IP addresses of these terminals are assigned by a DHCP server in the higher level network where they are connected, the IP address may differ each time the unit transmits data.

The Global Address Detection feature detects the current global IP address and, if the IP address has changed, sets it automatically to the SIP server. There are 2 methods, using STUN (Simple Traversal of UDP through NATs) or SIP messages, to perform this feature. For details about specifying this setting through the Web user interface, see **4.4.4 Global Address Detection**.

Note

- For details about server information, consult your network administrator.

Section 2

General Information on Programming

This section describes the various ways of programming the unit.

2.1 Overview of Programming

There are 3 types of programming, as shown in the table below:

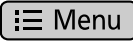
Programming Type	Description	References
Phone user interface programming	Configuring the unit's settings directly from the unit (via  Menu on the Phone screen or the [Settings] menu).	→ 2.2 Phone User Interface Programming → Section 3 Phone User Interface Programming
Web user interface programming	Configuring the unit's settings by accessing the Web user interface from a PC connected to the same network.	→ 2.3 Web User Interface Programming → Section 4 Web User Interface Programming
Configuration file programming	Configuring the unit's settings beforehand by creating configuration files (pre-provisioning), and having the unit download the files from a server or an SD card and configure its own settings (provisioning).	→ 2.4 Configuration File Programming → Section 5 Configuration File Programming

2.2 Phone User Interface Programming

You can change the settings directly from the unit.

For details about the operations, refer to the Operating Instructions on the Panasonic Web site (→ see **Introduction**).

For more details about phone user interface programming, see **Section 3 Phone User Interface Programming**.

2.2.1 Changing the Language for Phone User Interface Programming

You can change the language used on the LCD. Because the language settings for the LCD of the unit are not synchronized, you must set the languages individually for the unit.

For details about changing the setting, refer to the Operating Instructions on the Panasonic Web site (→ see **Introduction**).

2.3 Web User Interface Programming

After connecting the unit to your network, you can configure the unit's settings by accessing the Web user interface from a PC connected to the same network. For details, see **Section 4 Web User Interface Programming**.

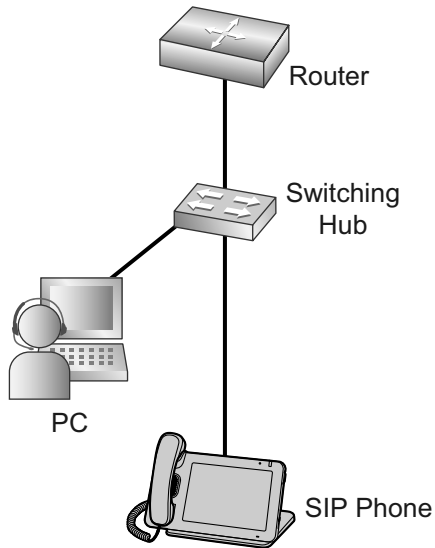

Note

- Connect the switching hub to the unit's LAN port. The unit will not connect properly if you connect to the unit's PC port.
- While the unit is connected to a switching hub, you can also perform Web user interface programming by connecting a PC to the unit's PC port.
- You can perform Web user interface programming by connecting a PC directly to the unit without using a switching hub or router. In this case, connect the PC to the LAN port of the unit.

2.4 Configuration File Programming

You can make settings by creating a configuration file in advance (→ see **2.4.2 Pre-provisioning**). Also, the unit can be set by downloading configuration files from a server (→ see **2.4.3 Provisioning**). For details about programming configuration files, see **Section 5 Configuration File Programming**.

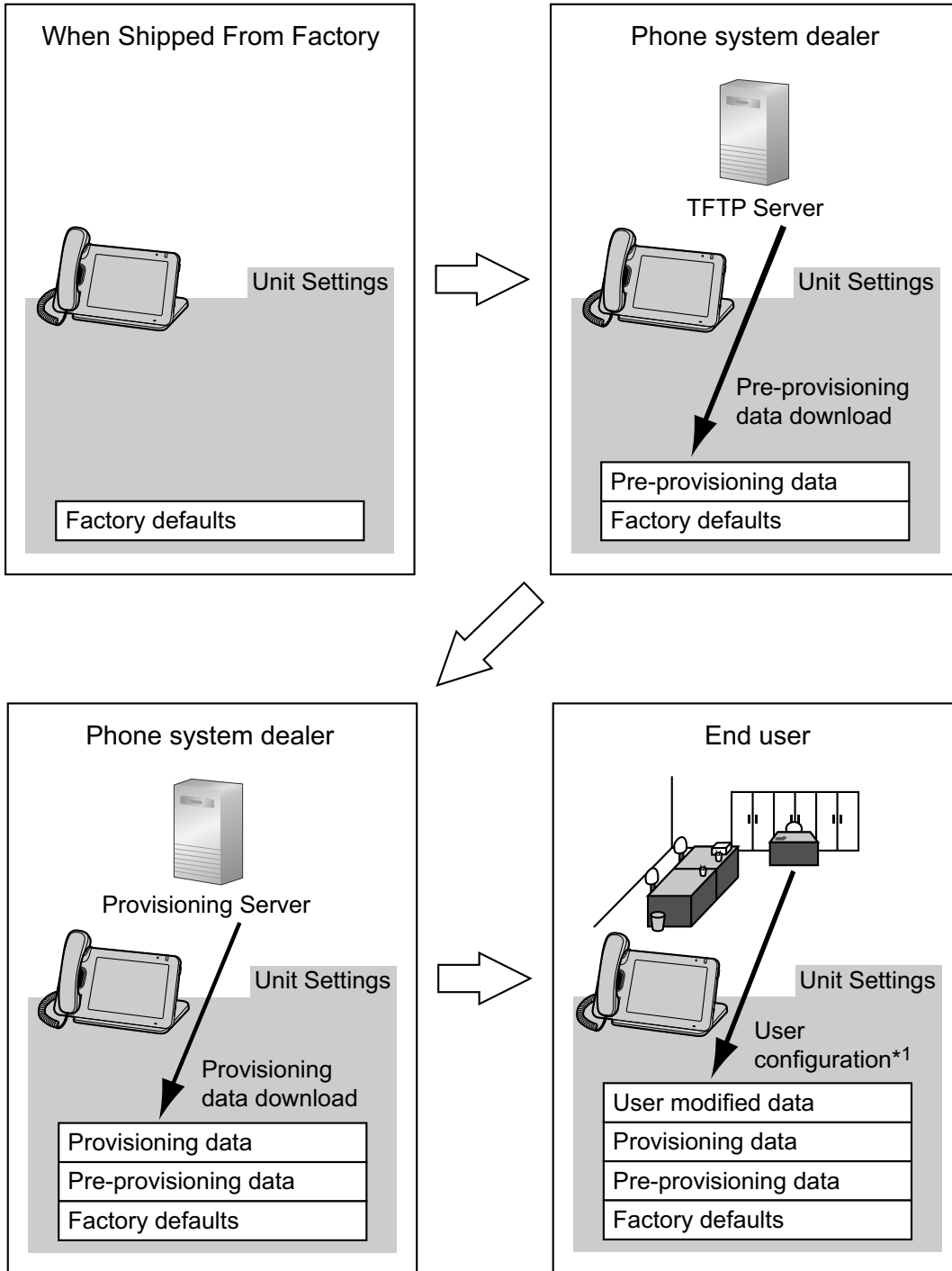

*1 User configuration refers to Phone user interface programming and Web user interface programming.

2.4.1 Configuration File Programming Methods

There are 2 methods to program configuration files:

- **Plain text provisioning:** a provisioning method using plain text configuration files.
- **XML provisioning:** a provisioning method using XML formatted configuration files.

The examples in **2.4.2 Pre-provisioning** and **2.4.3 Provisioning** use the plain text provisioning method. For details about XML provisioning, see **2.4.4 XML Provisioning**.

2.4.2 Pre-provisioning

2.4.2.1 What is Pre-provisioning?

Pre-provisioning can aid the installation process by allowing phone system dealers to configure beforehand the minimum settings required to operate the unit.

For example, phone system dealers can store on the TFTP server a configuration file that contains only the URL of a server where another configuration file is stored. This second configuration file contains settings configured specifically for the usage environment of the user. The user will be able to start using the unit by just connecting it to the network.

To perform pre-provisioning, you must set the IP address of a TFTP server to the DHCP server option 66 so that the unit can acquire the TFTP server address. When the unit starts up and no configuration has been applied, it will automatically acquire the address of the TFTP server and download the configuration file.

To restore settings configured by pre-provisioning, return the unit to its factory default state by performing a reset. You can reperform pre-provisioning after resetting the unit.

For details about resetting the unit, see **Section 9 Resetting the Unit**.

2.4.2.2 Server for Pre-provisioning

To perform pre-provisioning, the unit needs to acquire the TFTP server address from option 66 on a DHCP server. Therefore, pre-provisioning cannot be performed if you use static IP addressing on your network. If you use static IP addressing and want to perform pre-provisioning, construct a small, separate network and connect a DHCP and TFTP server to that network.

The DHCP server and TFTP server play important roles in performing pre-provisioning. This section explains their purposes, uses, and brief descriptions.

Server	Purpose	Description
DHCP server	Used to provide the address of a TFTP server, set in option 66 of the DHCP server.	In option 66 of the DHCP server, specify the IP address or FQDN (Fully Qualified Domain Name) of the TFTP server. For details, refer to the documentation for your DHCP server. Note <ul style="list-style-type: none"> • The maximum length of FQDN text is 64 bytes.
TFTP server	Used to store configuration files, and is set as the access point for downloading them automatically.	The unit will download the configuration file "KX-UT670.cfg" stored in the root directory of the TFTP server.

DHCP and TFTP servers may be supplied with your operating system, provided through commercial services, and are also distributed freely on the Internet. Use a server setup that best matches your environment. When installing and setting up the DHCP server and TFTP server, refer to the documentation supplied with the product.

2.4.2.3 Pre-provisioning Setting Example

This section gives an example of how to perform pre-provisioning.

Setting Example

Item	Description/Setting
TFTP server address	192.168.0.130
Distribution directory of TFTP server	/tftpboot
Model name of the unit	KX-UT670
MAC address of the unit	0080F0123456
Provisioning server name (the server domain name or URI where the configuration file used for provisioning is to be stored)	provisioning.example.com
File name of the configuration file used for provisioning	Config0080F0123456.cfg
URL of the configuration file used for provisioning	http://provisioning.example.com/Config0080F0123456.cfg
DHCP server option 66	192.168.0.130
IP address range assigned by DHCP server	192.168.0.16 to 192.168.0.63
File name of the configuration file used for pre-provisioning	KX-UT670.cfg
The setting example as set in KX-UT670.cfg	<pre>CFG_STANDARD_FILE_PATH="http://provisioning.example.com/Config{MAC}.cfg"</pre> <p>Note</p> <ul style="list-style-type: none"> "{MAC}" is replaced by the MAC address of the unit. (e.g., "0080F0123456")

Step 1

Connect the unit to the network, and turn the power on.

- The unit is assigned the IP address "192.168.0.16" by the DHCP server.
- The unit receives the TFTP server address "192.168.0.130" from the DHCP server using DHCP server option 66.

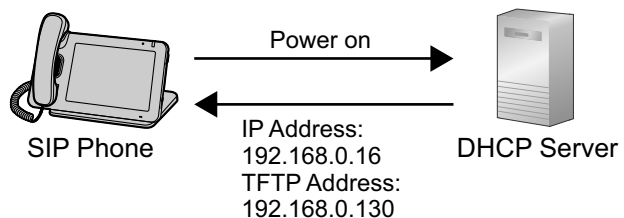

Step 2

The unit downloads the configuration file for pre-provisioning from the TFTP server.

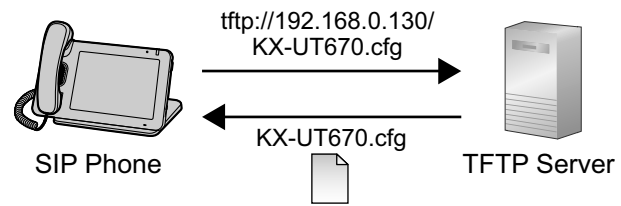
**Step 3**

The URL of the server where the configuration file for provisioning is stored (provisioning server) is set to the unit.

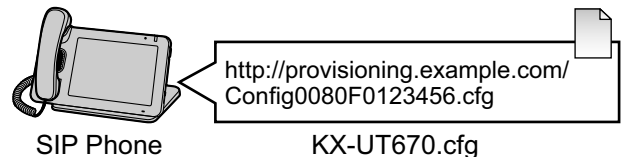
**Step 4**

The unit will automatically restart. When the unit is distributed to end users and started up in real circumstances, provisioning will be performed correctly.

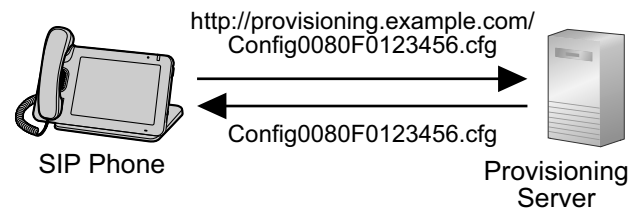

2.4.3 Provisioning

2.4.3.1 What is Provisioning?

After pre-provisioning has been performed (→ see **2.4.2 Pre-provisioning**), you can set up the unit automatically by downloading the configuration file stored on the provisioning server into the unit. This is called "provisioning".

2.4.3.2 Protocols for Provisioning

Provisioning can be performed over HTTP, HTTPS, FTP, and TFTP. The protocol you should use differs depending on how you will perform provisioning. Normally, HTTP, HTTPS, or FTP is used for provisioning. If you are transmitting encrypted configuration files, it is recommended that you use HTTP. If you are transmitting unencrypted configuration files, it is recommended that you use HTTPS. You may not be able to use FTP depending on the conditions of the network router or the network to be used.

2.4.3.3 Configuration File

This section gives concrete examples of the functions of the configuration file and how to manage it. The configuration file is a text file that contains the various settings that are necessary for operating the unit. The files are normally stored on a server maintained by your phone system dealer, and will be downloaded to the units as required. All configurable settings can be specified in the configuration file. You can ignore settings that already have the desired values. Only change parameters as necessary.

For details about setting parameters and their descriptions, see **Section 5 Configuration File Programming**.

Using 3 Types of Configuration Files

The unit can download up to 3 configuration files. One way to take advantage of this is by classifying the configuration files into the following 3 types:

Type	Usage
Master configuration file	<p>Configure settings that are common to all units, such as the SIP server address, and the IP addresses of the DNS and NTP (Network Time Protocol) servers managed by your phone system dealer. This configuration file is used by all the units.</p> <p>Example of the configuration file's URL: http://prov.example.com/ConfigCommon.cfg</p>
Product configuration file	<p>Configure settings that are required for a particular model. This configuration file is used by all the units that have the same model name.</p> <p>Example of the configuration file's URL: http://prov.example.com/Config{MODEL}.cfg</p> <p>Note</p> <ul style="list-style-type: none"> When a unit requests the configuration file, "{MODEL}" is replaced by the model name of the unit.
Standard configuration file	<p>Configure settings that are unique to each unit, such as the phone number, user ID, password, etc.</p> <p>Example of the configuration file's URL: http://prov.example.com/Config{MAC}.cfg</p> <p>Note</p> <ul style="list-style-type: none"> When a unit requests the configuration file, "{MAC}" is replaced by the MAC address of the unit.

Depending on the situation, you can use all 3 types of configuration files, and can also use only a standard configuration file.

2.4.3.4 Downloading Configuration Files

Downloading a Configuration File via the Web User Interface

The following procedure describes how to enable downloading a configuration file via the Web User Interface to be used for programming the unit.

1. Confirm that the provisioning server's IP address/FQDN and directory are correct, and store the configuration files in the directory (e.g., http://provisioning.example.com/Panasonic/Config_Sample.cfg).
2. Enter the IP address of the unit into the PC's Web browser (→ see **4.2.4 Accessing the Web User Interface**).
3. Log in as the administrator.
4. Click the **[Maintenance]** tab, click **[Provisioning Maintenance]**, and then select **[Yes]** for **[Enable Provisioning]**.
5. Enter the URL set up in Step 1 in **[Standard File URL]**.
6. Click **[Save]**.

Timing of Downloading

A unit downloads configuration files when it starts up, at regular intervals, and when directed to do so by the server. In addition, you can prohibit units from downloading the configuration files. For details about the settings, see **4.8.2 Provisioning Maintenance** and **5.4.5 Provisioning Settings**.

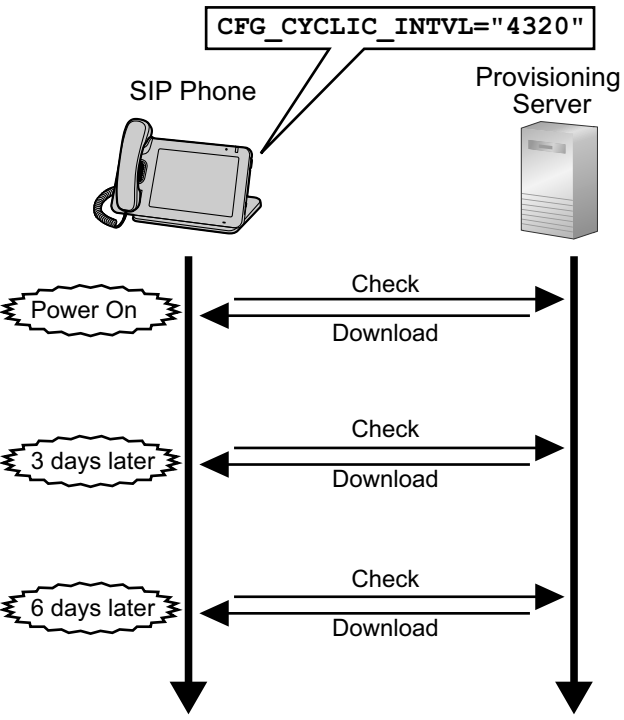
Download Timing	Explanation
Startup	The configuration files are downloaded when the unit starts up.
At regular intervals of time	<p>The configuration files are downloaded at specified intervals of time, set in minutes. In the example below, the unit has been programmed to check for and download configuration files from the provisioning server every 3 days (4320 minutes).</p>  <p>The configuration files are downloaded periodically under the following conditions:</p> <ul style="list-style-type: none"> • In the configuration file, add the line, <code>CFG_CYCLIC="Y"</code>. <ul style="list-style-type: none"> – Set an interval (minutes) by specifying "<code>CFG_CYCLIC_INTVL</code>". • In the Web user interface: <ul style="list-style-type: none"> – Click the [Maintenance] tab, click [Provisioning Maintenance], and then select [Yes] for [Cyclic Auto Resync]. – Enter an interval (minutes) in [Resync Interval]. <p>Note</p> <ul style="list-style-type: none"> • The interval may be determined by your phone system dealer. A maximum interval of 28 days (40320 minutes) can be set on the unit.

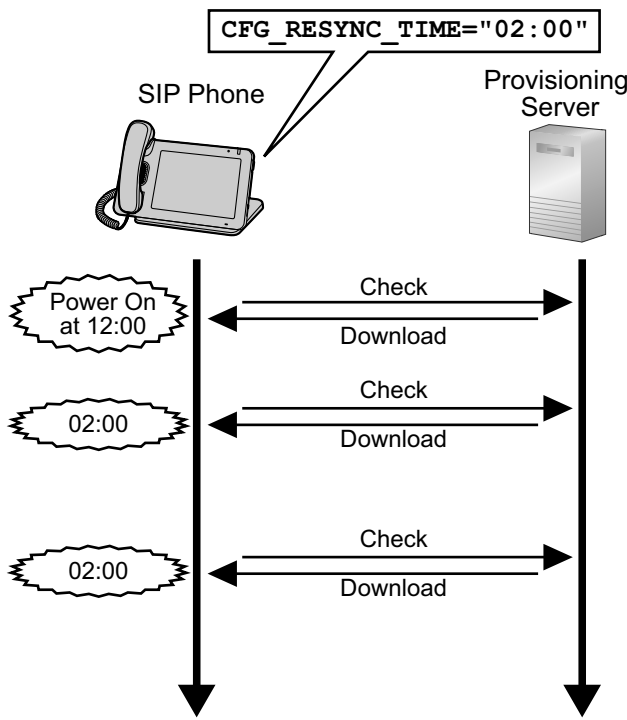
Download Timing	Explanation
<p>At a specified time each day</p>	<p>After the unit is powered on, it will check for and download configuration files once per day at the specified time.</p>  <p>The configuration files are downloaded at a set time each day:</p> <ul style="list-style-type: none"> • Set a time by specifying "CFG_RESYNC_TIME". <p>Note</p> <ul style="list-style-type: none"> • If the value for "CFG_RESYNC_TIME" is any valid value other than an empty string, the unit downloads the configuration files at the fixed time, and the settings specified in "CFG_CYCLIC", "CFG_CYCLIC_INTVL", and "CFG_RTRY_INTVL" are disabled. • The time is specified using a 24-hour clock ("00:00" to "23:59"). • The unit's date and time must be set in order to use this method.
<p>When directed</p>	<p>When a setting needs to be changed immediately, units can be directed to download the configuration files by sending them a NOTIFY message that includes a special event from the SIP server.</p> <ul style="list-style-type: none"> • In the configuration file: <ul style="list-style-type: none"> – Specify the special event text in "CFG_RESYNC_FROM_SIP". • In the Web user interface: <ul style="list-style-type: none"> – Click the [Maintenance] tab, click [Provisioning Maintenance], and then enter the special event text in [Header Value for Resync Event]. <p>Generally, "check-sync" or "resync" is set as the special event text.</p>

Download Timing	Explanation
None (prohibited)	<p>If you want to prohibit units from changing their settings by downloading configuration files, you can enable this function. The following operations will be prohibited:</p> <ul style="list-style-type: none"> – Provisioning at startup – Provisioning at regular intervals – Provisioning by sending a NOTIFY message • In the configuration file: <ul style="list-style-type: none"> – Add the line, <code>PROVISION_ENABLE="N"</code>. • In the Web user interface: <ul style="list-style-type: none"> – Click the [Maintenance] tab, click [Provisioning Maintenance], and then select [No] for [Enable Provisioning]. • To enable provisioning again, in the Web user interface: <ul style="list-style-type: none"> – Click the [Maintenance] tab, click [Provisioning Maintenance], and then select [Yes] for [Enable Provisioning].

2.4.3.5 Provisioning Server Setting Example

This section gives an example of how to set up the units and provisioning server when configuring 2 units with configuration files. The standard configuration files and the master configuration file are used in this example.

Conditions

Item	Description/Setting
Provisioning server FQDN	prov.example.com
Units' MAC addresses	<ul style="list-style-type: none"> • 0080F0111111 • 0080F0222222
URL of the configuration files	<p>Configure the following 2 settings either by pre-provisioning or through the Web user interface. The values of both settings must be the same.</p> <ul style="list-style-type: none"> • <code>CFG_STANDARD_FILE_PATH="http://prov.example.com/Config{MAC}.cfg"</code> • <code>CFG_MASTER_FILE_PATH="http://prov.example.com/ConfigCommon.cfg"</code>
File name of configuration files	<p>Store the following configuration files in the HTTP root directory.</p> <ul style="list-style-type: none"> • Contains the common settings for the 2 units (master configuration file): <ul style="list-style-type: none"> – ConfigCommon.cfg • Contains the settings unique to each unit (standard configuration files): <ul style="list-style-type: none"> – Config0080F0111111.cfg – Config0080F0222222.cfg

To set up the provisioning server

1. Connect the units to the network, and turn them on.
 - a. The unit with the MAC address 0080F0111111 accesses the following URLs:
 - http://prov.example.com/ConfigCommon.cfg
 - http://prov.example.com/Config0080F0111111.cfg
 - b. The unit with the MAC address 0080F0222222 accesses the following URLs:
 - http://prov.example.com/ConfigCommon.cfg
 - http://prov.example.com/Config0080F0222222.cfg

Example Provisioning Direction from the Server

The following figure shows an example NOTIFY message from the server, directing the units to perform provisioning. The text "check-sync" is specified for "CFG_RESYNC_FROM_SIP".

```
NOTIFY sip:1234567890@sip.example.com SIP/2.0
Via: SIP/2.0/UDP xxx.xxx.xxx.xxx:5060;branch=abcdef-ghijkl
From: sip:prov@sip.example.com
To: sip:1234567890@sip.example.com
Date: Thu, 1 Jan 2009 01:01:01 GMT
Call-ID: 123456-1234567912345678
CSeq: 1 NOTIFY
Contact: sip:xxx.xxx.xxx.xxx:5060
Event: check-sync
Content-Length: 0
```

2.4.3.6 Encryption

Transferring Encrypted Configuration Files

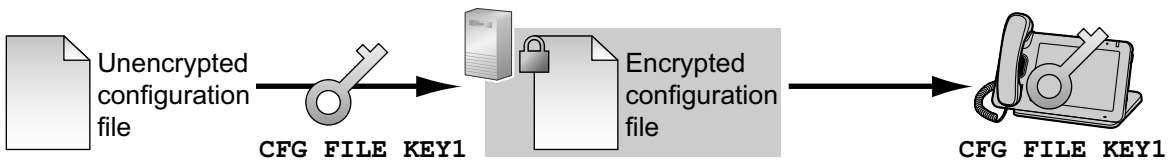

To use this method, an encryption key is required to encrypt and decrypt the configuration files. A preset encryption key unique to each unit, an encryption key set by your phone system dealer, etc., is used for the encryption. When the unit downloads an encrypted configuration file, it will decrypt the file using the same encryption key, and then configure the settings automatically.

To decrypt configuration files, the unit uses the encryption key registered to it beforehand. The unit determines the encryption status by checking the extension of the downloaded configuration file.

Extension of Configuration File	Configuration File Parameters Used for Decrypting
".e1c"	CFG_FILE_KEY1
".e2c"	CFG_FILE_KEY2
".e3c"	CFG_FILE_KEY3
Other than ".e1c", ".e2c", and ".e3c"	Processed as unencrypted configuration files.

2.4.4 XML Provisioning

XML provisioning is a provisioning method that uses XML formatted configuration files. XML provisioning consists of a configuration file (.xml) and a schema file (.xsd). The benefits of XML formatted configuration files are as follows:

- You can use an XML editor to edit configuration files, which prevents typos in the configuration parameters.
- XML formatted configuration files integrate better with server applications than plain text configuration files.

Note

- The maximum size of a configuration file is 240 KB.
- The configuration file does not necessarily need to have the ".xml" extension. However, it must start with a comment line containing "# Panasonic SIP Phone Standard Format File #".
- If you are transferring configuration files using an encryption key (→ see 2.4.3.6 Encryption), the file extension must be changed accordingly.

2.4.4.1 XML Structure

XML Syntax

XML configuration files each consist of an XML declaration and XML instance.

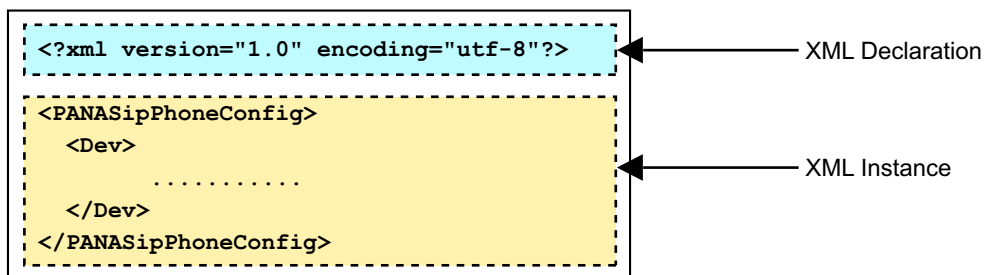
**[XML Declaration]**

The XML declaration contains the XML version and character set, as follows:

```
<?xml version="1.0" encoding="utf-8"?>
```

The XML version must be 1.0 and the character set must be UTF-8.

[XML Instance]

The XML instance contains the XML configuration data for programming the unit.

XML Schema File

The XML schema is a description of the type of XML document. The file name should be as follows:

- UT670_config.xsd

This is not a proprietary schema. The schema uses the "http://www.w3.org/2001/XMLSchema" namespace.

XML Element/Attribute Configuration Parameters

Common Description Rules

- Certain parameter names end with "[n]". This signifies that these settings can be made to each line individually. The unit supports 6 telephone lines.

Example:

```
UserAgentPort[n] SIP_SRC_PORT_[n]
  <UserAgentPort1 SIP_SRC_PORT_1="5060" />
  <UserAgentPort2 SIP_SRC_PORT_2="5070" />
  <UserAgentPort3 SIP_SRC_PORT_3="5080" />
  <UserAgentPort4 SIP_SRC_PORT_4="5090" />
  <UserAgentPort5 SIP_SRC_PORT_5="5100" />
  <UserAgentPort6 SIP_SRC_PORT_6="5110" />
```

- Certain parameter names end with "[x]". This signifies that these settings can be made to each button individually. Up to 24 buttons can be configured.

Example:

```
Button ID="[x]"
  <Button ID="1">
    <FacilityAction FLEX_BUTTON_FACILITY_ACT1="X_PANASONIC_IPTEL_DN" />
    <FacilityActionArgument FLEX_BUTTON_FACILITY_ARG1="1" />
    <ButtonMessage FLEX_BUTTON_LABEL1="" />
  </Button>
```

- Certain parameter names end with "[y]". This signifies that these settings can be made to each codec individually. The codecs are classified as follows:

- 0: G.722
- 1: PCMA
- 3: G.729A
- 4: PCMU

Example:

```
Codec.List ID="[y]"
  <Codec>
    <List ID="0">
      <Enable CODEC_ENABLE0_1="Y" />
      <Priority CODEC_PRIORITY0_1="1" />
    </List>
    <List ID="1">
      <Enable CODEC_ENABLE1_1="Y" />
      <Priority CODEC_PRIORITY1_1="1" />
    </List>
  </Codec>
```

Predefined Entities of XML

The following entities must be used when rendering the following characters in XML.

Character	Entity	Description
"	"	Quotation mark
&	&	Ampersand
'	'	Apostrophe
<	<	Less-than sign
>	>	Greater-than sign

2.4.4.2 XML Element/Attribute Configuration Parameter Table

Element	Attribute (Configuration Parameter)	Ref.
PANASipPhoneConfig	–	–
Dev	–	–
Srv	–	–
Prof	–	–
Enable	PROFILE_ENABLE [n]	Page 190
DTMFMethod	OUTBANDDTMF_ [n]	Page 182
DigitMap	DIAL_PLAN_ [n]	Page 185
SIP	–	–
ProxyServer	SIP_PRXY_ADDR_ [n]	Page 191
ProxyServerPort	SIP_PRXY_PORT_ [n]	Page 191
ProxyServerTransport	SIP_TRANSPORT_ [n]	Page 205
RegistrarServer	SIP_RGSTR_ADDR_ [n]	Page 191
RegistrarServerPort	SIP_RGSTR_PORT_ [n]	Page 192
UserAgentDomain	SIP_SVCDOMAIN_ [n]	Page 192
UserAgentPort [n]	SIP_SRC_PORT_ [n]	Page 191
OutboundProxy	SIP_OUTPROXY_ADDR_ [n]	Page 204
OutboundProxyPort	SIP_OUTPROXY_PORT_ [n]	Page 205
TimerT1	SIP_TIMER_T1_ [n]	Page 195
TimerT2	SIP_TIMER_T2_ [n]	Page 195
TimerT4	SIP_TIMER_T4_ [n]	Page 196
TimerB	SIP_TIMER_B_ [n]	Page 207
TimerD	SIP_TIMER_D_ [n]	Page 207
TimerF	SIP_TIMER_F_ [n]	Page 208
TimerH	SIP_TIMER_H_ [n]	Page 208
TimerJ	SIP_TIMER_J_ [n]	Page 208
InviteExpires	SIP_INVITE_EXPIRE_ [n]	Page 198

Element	Attribute (Configuration Parameter)	Ref.
RegisterExpires	REG_EXPIRE_TIME_[n]	Page 192
RegisterRetryInterval	REG_RTX_INTVL_[n]	Page 203
DSCPMark	DSCP_SIP_[n]	Page 193
X_P_IPTEL_RegisterIntervalRate	REG_INTERVAL_RATE_[n]	Page 193
DetectReceiveToHeader	SIP_RCV_DET_HEADER_[n]	Page 206
X_P_IPTEL_SIPProxyServer	SIP_2NDPROXY_ADDR_[n]	Page 194
X_P_IPTEL_SIPProxyServerPort2	SIP_2NDPROXY_PORT_[n]	Page 194
X_P_IPTEL_SIPRegistrarServer2	SIP_2NDRGSTR_ADDR_[n]	Page 194
X_P_IPTEL_SIPRegistrarServerPort2	SIP_2NDRGSTR_PORT_[n]	Page 195
SIPRequestURIPort	SIP_REQURI_PORT_[n]	Page 201
EventSubscribe	-	-
Notifier	SIP_PR SNC_ADDR_[n]	Page 199
NotifierPort	SIP_PR SNC_PORT_[n]	Page 199
ExpireTime	SIP_SUBS_EXPIRE_[n]	Page 202
X_P_IPTEL_SIPNotifier2	SIP_2NDPR SNC_ADDR_[n]	Page 200
X_P_IPTEL_SIPNotifierPort2	SIP_2NDPR SNC_PORT_[n]	Page 200
RTP	-	-
LocalPortMin	RTP_PORT_MIN	Page 180
LocalPortMax	RTP_PORT_MAX	Page 180
DSCPMark	DSCP_RTP_[n]	Page 178
TelephoneEventPayloadType	TELEVENT_PAYLOAD	Page 183
RTCP	-	-
Enable	RTCP_ENABLE_[n]	Page 181
TxRepeatInterval	RTCP_INTVL_[n]	Page 179

Element	Attribute (Configuration Parameter)	Ref.
ButtonMap	–	–
Button	ID=" [x] " ([x]:1–24)	–
FacilityAction	FLEX_BUTTON_FACILITY_ACT[x]	Page 175
FacilityActionArgument	FLEX_BUTTON_FACILITY_ARG[x]	Page 175
ButtonMessage	FLEX_BUTTON_LABEL[x]	Page 176
Codec	–	–
PacketizationPeriod	RTP_PTIME	Page 181
Line	ID=" [n] "	–
Enable	LINE_ENABLE_[n]	Page 189
DirectoryNumber	PHONE_NUMBER_[n]	Page 189
SIP	–	–
AuthUserName	SIP_AUTHID_[n]	Page 190
AuthPassword	SIP_PASS_[n]	Page 190
URI	SIP_URI_[n]	Page 189
CallingFeatures	–	–
CallerIDName	DISPLAY_NAME_[n]	Page 184
CallWaitingEnable	CW_ENABLE_[n]	Page 187
CallFeat	–	–
X_P_IPTEL_VoiceMailAccessNumber	VM_NUMBER_[n]	Page 184
X_P_IPTEL_DialPlanNotMatchEnable	DIAL_PLAN_NOT_MATCH_ENABLE_[n]	Page 185
X_P_IPTEL_SharedCallEnable	SHARED_CALL_ENABLE_[n]	Page 186
X_P_IPTEL_FwdDndSynchroEnable	FWD_DND_SYNCHRO_ENABLE_[n]	Page 186

Element	Attribute (Configuration Parameter)	Ref.
X_P_IPTEL_ResourceListUri	RESOURCELIST_URI_[n]	Page 187
Codec	-	-
List	ID=" [y] " ([y]:0-4)	-
Enable	CODEC_ENABLE[y]_[n]	Page 177
Priority	CODEC_PRIORITY[y]_[n]	Page 177
X_P_IPTEL_SIP	-	-
SessionTimer	SIP_SESSION_TIME_[n]	Page 193
SessionMethod	SIP_SESSION_METHOD_[n]	Page 193
FailoverEnable	SIP_FOVR_NORSP_[n]	Page 196
FailoverMax	SIP_FOVR_MAX_[n]	Page 196
RefresherParameter	SIP_REFRESHER_[n]	Page 197
DNSSrvEnable	SIP_DNSSRV_ENA_[n]	Page 197
UDPSrvPrefix	SIP_UDP_SRV_PREFIX_[n]	Page 197
TCPSrvPrefix	SIP_TCP_SRV_PREFIX_[n]	Page 198
SIP100relEnable	SIP_100REL_ENABLE_[n]	Page 198
SIP18XRetransmitInterval	SIP_18X_RTX_INTVL_[n]	Page 199
DelRegisterOpenEnable	USE_DEL_REG_OPEN_[n]	Page 200
DelRegisterCloseEnable	USE_DEL_REG_CLOSE_[n]	Page 200
UserPhoneEnable	ADD_USER_PHONE_[n]	Page 203
TransportUDPEnable	ADD_TRANSPORT_UDP_[n]	Page 208
DelRegisterExpiresEnable	ADD_EXPIRES_HEADER_[n]	Page 209
AddRport	SIP_ADD_RPORT_[n]	Page 201
SubscribeFailerRetryInterval	SUB_RTX_INTVL_[n]	Page 202
PortPunchInterval	PORT_PUNCH_INTVL_[n]	Page 201
DetectSSAF	SIP_DETECT_SSAF_[n]	Page 206

Element	Attribute (Configuration Parameter)	Ref.
SubscribeIntervalRate	SUB_INTERVAL_RATE_[n]	Page 204
HoldReceiveEnable	SIP_HOLD_HOLDRECEIVE_[n]	Page 209
ContactHeaderOnACK	SIP_CONTACT_ON_ACK_[n]	Page 207
AnonymousDisplayName	SIP_ANM_DISPNAME_[n]	Page 205
AnonymousUserName	SIP_ANM_USERNAME_[n]	Page 205
AnonymousHostName	SIP_ANM_HOSTNAME_[n]	Page 206
PreferredIDEnable	SIP_P_PREFERRED_ID_[n]	Page 203
PrivacyEnable	SIP_PRIVACY_[n]	Page 203
AddDiversionHeader	SIP_ADD_DIVERSION_[n]	Page 209
X_P_IPTEL_SDP	–	–
RTCPSendBySDP	RTCP_SEND_BY_SDP_[n]	Page 182
UserID	SDP_USER_ID_[n]	Page 204
RFC2543HoldEnable	RFC2543_HOLD_ENABLE_[n]	Page 183
RTPCloseEnable	RTP_CLOSE_ENABLE_[n]	Page 182
X_P_IPTEL_Jitter	–	–
MaxDelay	MAX_DELAY_[n]	Page 179
MinDelay	MIN_DELAY_[n]	Page 179
NormalDelay	NOM_DELAY_[n]	Page 180
Time	–	–
NTPServer1	NTP_ADDR	Page 157
LocalTimeZone_TIME_ZONE	TIME_ZONE_COUNTRY	Page 141
X_PANASONIC_IPTEL_ErrorRetryInterval	TIME_SYNC_INTVL	Page 157
X_PANASONIC_IPTEL_SynchronizationInterval	TIME_QUERY_INTVL	Page 157
LAN	–	–
X_P_IPTEL_NwSettingEnable	NW_SETTING_ENABLE	Page 158
X_P_IPTEL_HTTP	–	–

Section 2 General Information on Programming

Element	Attribute (Configuration Parameter)	Ref.
Version	HTTP_VER	Page 155
CustomWebPage	CUSTOM_WEB_PAGE	Page 159
UserAgent	HTTP_USER_AGENT	Page 155
SSLVerify	HTTP_SSL_VERIFY	Page 156
CertificateFileURL	CFG_ROOT_CERTIFICATE_PATH	Page 156
X_P_IPTEL_Codec	–	–
CodecG711requirement	CODEC_G711_REQ	Page 176
CodecG729Parameter	CODEC_G729_PARAM	Page 177
X_P_IPTEL_STUN	–	–
ServerAddress	STUN_SERV_ADDR	Page 157
ServerPort	STUN_SERV_PORT	Page 158
ServerAddress2	STUN_2NDSERV_ADDR	Page 158
ServerPort2	STUN_2NDSERV_PORT	Page 158
X_P_IPTEL_Syslog	–	–
SyslogAddress	SYSLOG_ADDR	Page 143
SyslogPort	SYSLOG_PORT	Page 143
X_P_IPTEL_HTTPD	–	–
AdminID	ADMIN_ID	Page 140
AdminPass	ADMIN_PASS	Page 140
UserID	USER_ID	Page 140
UserPass	USER_PASS	Page 140
AutoPortOpenEnable	HTTPD_PORTOPEN_AUTO	Page 154
X_P_IPTEL_SIP	–	–
UserAgent	SIP_USER_AGENT	Page 188
ResCode	–	–
Dnd	SIP_RESPONSE_CODE_DND	Page 210

Element	Attribute (Configuration Parameter)	Ref.
CallReject	SIP_RESPONSE_CODE_CALL_REJECT	Page 210
X_P_IPTEL_LLDP	–	–
Enable	LLDP_ENABLE	Page 151
Interval	LLDP_INTERVAL	Page 152
PcID	LLDP_VLAN_ID_PC	Page 152
PcPriority	LLDP_VLAN_PRI_PC	Page 152
X_P_IPTEL_VLAN	–	–
Enable	VLAN_ENABLE	Page 152
IpPhoneID	VLAN_ID_IP_PHONE	Page 153
IpPhonePriority	VLAN_PRI_IP_PHONE	Page 153
PcID	VLAN_ID_PC	Page 154
PcPriority	VLAN_PRI_PC	Page 154
X_P_IPTEL_Provisioning	–	–
ProvisionEnable	PROVISION_ENABLE	Page 145
Option66Enable	OPTION66_ENABLE	Page 144
StandardFileURL	CFG_STANDARD_FILE_PATH	Page 145
ProductFileURL	CFG_PRODUCT_FILE_PATH	Page 146
MasterFileURL	CFG_MASTER_FILE_PATH	Page 147
CyclicEnable	CFG_CYCLIC	Page 149
CyclicInterval	CFG_CYCLIC_INTVL	Page 150
RetryInterval	CFG_RTRY_INTVL	Page 150
ResyncTime	CFG_RESYNC_TIME	Page 150
Key1	CFG_FILE_KEY1	Page 148
Key2	CFG_FILE_KEY2	Page 149
Key3	CFG_FILE_KEY3	Page 149
AesKeyLength	CFG_FILE_KEY_LENGTH	Page 149
ResyncEvent	CFG_RESYNC_FROM_SIP	Page 151
X_P_IPTEL_Update	–	–

Section 2 General Information on Programming

Element	Attribute (Configuration Parameter)	Ref.
Enable	FIRM_UPGRADE_ENABLE	Page 143
Version	FIRM_VERSION	Page 143
FirmwareFileURL	FIRM_FILE_PATH	Page 144
X_P_IPTEL_CallCtrl	-	-
VMSubscribeEnable	VM_SUBSCRIBE_ENABLE	Page 159
TalkPackageEnable	TALK_PACKAGE	Page 162
HoldPackageEnable	HOLD_PACKAGE	Page 162
RingingOffSettingEnable	RINGING_OFF_SETTING_ENABLE	Page 163
AutoCallHoldEnable	AUTO_CALL_HOLD	Page 163
RedialKeyCallLogEnable	REDIALKEY_CALLLOG_ENABLE	Page 164
OnHookTransferEnable	ONHOOK_TRANSFER_ENABLE	Page 164
InternationalCallPrefix	INTERNATIONAL_ACCESS_CODE	Page 161
CountryCallingCode	COUNTRY_CALLING_CODE	Page 161
NationalAccessCode	NATIONAL_ACCESS_CODE	Page 161
SystemOptions	-	-
DisconnectionMode	DISCONNECTION_MODE	Page 164
FlashRecallTerminate	FLASH_RECALL_TERMINATE	Page 187
FlashHookContentType	FLASHHOOK_CONTENT_TYPE	Page 188
PoundKeyDelimiterEnable	POUND_KEY_DELIMITER_ENABLE	Page 174
DefaultLine	DEFAULT_LINE_SELECT	Page 161
Timers	-	-
FirstDigitTimeout	FIRSTDIGIT_TIM	Page 160
IntDigitTim	INTDIGIT_TIM	Page 160
MacroDigitTimeout	MACRODIGIT_TIM	Page 160
HoldRecallTimer	HOLD_RECALL_TIM	Page 163
DisconnectToneLenHandsfree	TONE_LEN_DISCONNECT_HANDSET	Page 164
ToneLenDisconnectHandsfree	TONE_LEN_DISCONNECT_HANDSFREE	Page 165
AutoAnswerRingTimer	AUTO_ANS_RING_TIM	Page 163

Element	Attribute (Configuration Parameter)	Ref.
PickupDirect	NUM_PLAN_PICKUP_DIRECT	Page 162
X_P_IPTEL_DTMF	–	–
SignalLen	DTMF_SIGNAL_LEN	Page 184
InterDigitLen	DTMF_INTDIGIT_TIM	Page 184
X_P_IPTEL_TelSetting	–	–
DisplayNameReplace	DISPLAY_NAME_REPLACE	Page 172
NumberMatchingLowerDigi	NUMBER_MATCHING_LOWER_DIGIT	Page 172
NumberMatchingUpperDigit	NUMBER_MATCHING_UPPER_DIGIT	Page 172
UserInterface	–	–
DatePattern	DISPLAY_DATE_PATTERN	Page 173
TimePattern	DISPLAY_TIME_PATTERN	Page 173
DefaultLanguage	DEFAULT_LANGUAGE	Page 173
X_P_IPTEL_UserSettings	–	–
DataLineMode	DATA_LINE_MODE	Page 162
X_P_IPTEL_Tone	–	–
Description1	–	–
Frequency	DIAL_TONE1_FRQ	Page 166
Gain	DIAL_TONE1_GAIN	Page 166
Timing	DIAL_TONE1_TIMING	Page 166
Description2	–	–
Frequency	DIAL_TONE2_FRQ	Page 166
Gain	DIAL_TONE2_GAIN	Page 167
Timing	DIAL_TONE2_TIMING	Page 167
Description3	–	–
Frequency	DIAL_TONE4_FRQ	Page 167

Section 2 General Information on Programming

Element	Attribute (Configuration Parameter)	Ref.
Gain	DIAL_TONE4_GAIN	Page 167
Timing	DIAL_TONE4_TIMING	Page 167
Description4	–	–
Frequency	BUSY_TONE_FRQ	Page 168
Gain	BUSY_TONE_GAIN	Page 168
Timing	BUSY_TONE_TIMING	Page 168
Description5	–	–
Frequency	REORDER_TONE_FRQ	Page 169
Gain	REORDER_TONE_GAIN	Page 169
Timing	REORDER_TONE_TIMING	Page 169
Description6	–	–
Frequency	RINGBACK_TONE_FRQ	Page 169
Gain	RINGBACK_TONE_GAIN	Page 170
Timing	RINGBACK_TONE_TIMING	Page 170
Description7	–	–
Frequency	HOLD_ALARM_FRQ	Page 170
Gain	HOLD_ALARM_GAIN	Page 170
Timing	HOLD_ALARM_TIMING	Page 170
Description8	–	–
Frequency	CW_TONE1_FRQ	Page 171
Gain	CW_TONE1_GAIN	Page 171
Timing	CW_TONE1_TIMING	Page 171
Description9	–	–
Frequency	HOLD_TONE_FRQ	Page 171
Gain	HOLD_TONE_GAIN	Page 171
Timing	HOLD_TONE_TIMING	Page 172

2.4.4.3 Editing XML Configuration Files on your PC

You can edit XML configuration files using Microsoft® XML Notepad 2007, which can be downloaded from the Microsoft Web site. It is useful for basic editing and checking the configuration file using the schema file before uploading to the unit.

The following procedure describes how to read a schema file.

1. Select **[View]** and then select **[Schemas]**.
2. Select **[File]** and then select **[Add schemas]**.
3. Navigate to the schema file you want to open and then click **[Open]**.
4. Click **[OK]**.

2.4.5 Loading Settings Using the SD card

You can load configuration file settings from an SD card. All settings made in configuration files can be configured using this method.

Configuration file preparation

Notice

- Format the SD card before use. For details about formatting, refer to the Operating Instructions on the Panasonic Web site (→ see **Introduction**).
1. Prepare an SD card.
For details about supported SD cards, refer to the Panasonic Web site (→ see **Introduction**).
 2. Create a configuration file using a computer's text editor (→ see **5.2.1 Configuration File Specifications for Plain Text Provisioning**).
 3. Save the created configuration file in the root directory of the SD card.

To load the configuration file from the SD card

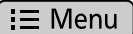
1. Insert the SD card into the unit.
2. Press  **Menu** on the Home screen, and then tap **[Settings]**.
3. Tap **[Administration]**, enter the administrator password, and then tap **[OK]**.
4. Tap **[Import Configuration file]**.
5. Select the type of configuration file (→ see **2.4.3.3 Configuration File**).
6. Select the file name.
7. Tap **[Import and Restart]**.



Note

- In addition to programming the unit, the following functions can be performed using an SD card.
 - Updating the firmware (→ see **7.4 Firmware Update Using the SD Card**).
 - Installing applications (→ see **6.5 Adding Applications**).
- For details about the administrator password, see **3.1.2 Phone User Interface Administrator Menu**.

2.5 Priority of Setting Methods

The same settings can be configured by different configuration methods: provisioning, Web user interface programming, etc. This section explains which value is applied when the same setting is specified by multiple methods.

The following table shows the priority with which settings from each method are applied:

Priority	Setting Method
High   Low	Settings configured from the Web user interface or the phone user interface (via  Menu on the Home screen or the [Settings] menu)
	Provisioning with the standard configuration file
	Provisioning with the product configuration file
	Provisioning with the master configuration file
	Pre-provisioning with the configuration file
	The factory default settings for the unit

If different values are specified for the same setting by the master configuration file and Web user interface programming, the value specified from the Web user interface is applied. This is because values specified from the Web user interface have a higher priority.

For settings configured from the Web user interface and the phone user interface, the value specified most recently receives priority.

Notice

- Make sure to perform Reset to Factory Default before connecting the unit to a different phone system. For details, see **9.1 Resetting to Factory Default and Clearing Data/Settings**.

Note

- In the case of flexible button settings, configuration file programming has a higher priority than phone user interface programming.

Section 3

Phone User Interface Programming

This section explains how to configure the unit through the phone user interface.

3.1 Phone User Interface Programming

This section provides information about the features that can be configured directly from the unit, but that are not mentioned in the Operating Instructions.

For details about the other available features, settings and operations on the phone user interface, refer to the Operating Instructions on the Panasonic Web site (→ see **Introduction**).

3.1.1 Direct Commands

The following table shows additional features programmable with direct commands. These commands are hidden from end users.

Direct Command	Feature	Ref.
[#][7][3][1]	Terminal No.	Page 48
[#][7][3][9]	Reset Web ID/Password ^{*1}	Page 48

^{*1} Not displayed on the LCD of the unit.



Notice

- Direct commands cannot be performed if a USB keyboard is connected to the unit. Disconnect the USB keyboard before performing direct commands.

3.1.1.1 Terminal Number Settings

You can select the terminal number of the unit that you are using from **[Terminal 1]**–**[Terminal 9]**, and **[Auto]**. The default setting is **[Auto]**. **[Auto]** does not assign a fixed terminal number to the unit. If multiple units try to access the same router simultaneously, errors can occur. Assigning a terminal number 1 to 9 to each of the units may prevent such errors.

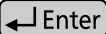

To assign a terminal number to the unit

1. Press  **Menu** on the Home screen, and then tap **[Settings]**.
2. Tap **[About phone]**.
3. Press and hold .
4. When the keyboard is displayed, enter **[#][7][3][1]**, and then press .
5. Select the desired terminal number (**[Auto]**, **[Terminal 1]**–**[Terminal 9]**).

3.1.1.2 Reset Web ID/Password

Reset Web ID/Password resets all the IDs and passwords required for users and administrators to access the Web user interface (→ see **Access Levels (IDs and Passwords)** in **4.2.3 Before Accessing the Web User Interface**) to their factory defaults. You can perform this operation from the unit.

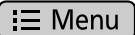
To perform Reset Web ID/Password

1. Press  **Menu** on the Home screen, and then tap **[Settings]**.
2. Tap **[About phone]**.
3. Press and hold .
4. When the keyboard is displayed, enter **[#][7][3][9]**, and then press .

5. Tap **[OK]** to confirm the reset.

Notice

- For security reasons, it is recommended that the passwords are set again immediately (→ see **4.5.2 Administrator Password** or **4.5.3 Change User Password**).

3.1.2 Phone User Interface Administrator Menu

The unit's administrator password is necessary to access the **[Administration]** menu on the unit. In this menu, the administrator can configure the following settings:

Feature	Ref.
Ethernet port settings	Page 17
Import Configuration file	Page 45
Applications	Page 213
Update Firmware	Page 222
Backup and Restore	Page 224
Customize	Page 212
Administrator password	Page 49

The unit's administrator password is the same as the administrator password for Web user interface programming and the default is also the same. For details, see **Access Levels (IDs and Passwords)** in **4.2.3 Before Accessing the Web User Interface**.

The password can consist of 6 to 16 ASCII characters (case-sensitive) (→ see **Entering Characters** in **4.2.4 Accessing the Web User Interface**).

Notice

- You should manage passwords carefully, and change them regularly.

To access the unit's administrator menu

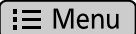
1. Press  **Menu** on the Home screen, and then tap **[Settings]**.
2. Tap **[Administration]**, enter the administrator password, and tap **[OK]**.

Notice

- When logging in for the first time, enter the default administrator password ("adminpass"). After logging in, tap **[Administrator password]** and change the password (→ see **To change the administrator password** in this section).

Note

- You can also change the administrator password using Web user interface programming (→ see **4.5.2.1 Change Administrator Password**) or configuration file programming (→ see **5.4.1 Login Account Settings**).
3. When the **[Administration]** menu is displayed, make the necessary settings.
 4. Tap **[Exit]** to logout.

To change the administrator password

1. Press  **Menu** on the Home screen, and then tap **[Settings]**.

2. Tap **[Administration]**, enter the administrator password, and tap **[OK]**.
3. Tap **[Administrator password]**, enter the new password, and enter it again for confirmation.
4. Tap **[OK]**.
5. Tap **[Exit]** to logout.

Note

- You can also change the administrator password using Web user interface programming (→ see **4.5.2.1 Change Administrator Password**) or configuration file programming (→ see **5.4.1 Login Account Settings**).

Section 4

Web User Interface Programming

This section provides information about the settings available in the Web user interface.

4.1 Web User Interface Setting List

The following tables show all the settings that you can configure from the Web user interface and the access levels. For details about each setting, see the reference pages listed.

For details about setting up Web user interface programming, see **2.3 Web User Interface Programming**.

Status

Menu Item	Section Title	Setting	Access Level ^{*1}		Ref.
			U	A	
Version Information	Version Information	Model	✓	✓	Page 66
		OS Version	✓	✓	Page 66
		Firmware Version	✓	✓	Page 66
Network Status	Network Status	MAC Address	✓	✓	Page 67
		Ethernet Link Status (LAN Port)	✓	✓	Page 67
		Ethernet Link Status (PC Port)	✓	✓	Page 67
		Connection Mode	✓	✓	Page 67
		IP Address	✓	✓	Page 67
		Subnet Mask	✓	✓	Page 67
		Default Gateway	✓	✓	Page 68
		DNS1	✓	✓	Page 68
		DNS2	✓	✓	Page 68
VoIP Status	VoIP Status	Line No.	✓	✓	Page 69
		Phone Number	✓	✓	Page 69
		VoIP Status	✓	✓	Page 69

^{*1} The access levels are abbreviated as follows:
 U: User; A: Administrator
 A check mark indicates that the setting is available for that access level.

Network

Menu Item	Section Title	Setting	Access Level ¹		Ref.
			U	A	
Basic Network Settings	Connection Mode	Connection Mode ²	✓ ³	✓	Page 70
	DHCP Settings	Host Name		✓	Page 70
		Domain Name Server ²	✓ ³	✓	Page 71
	Static Settings	Static IP Address ²	✓ ³	✓	Page 71
		Subnet Mask ²	✓ ³	✓	Page 72
		Default Gateway ²	✓ ³	✓	Page 72
		DNS1 ²	✓ ³	✓	Page 72
		DNS2 ²	✓ ³	✓	Page 72
Ethernet Port Settings	Link Speed/Duplex Mode	LAN Port ²		✓	Page 73
		PC Port ²		✓	Page 74
	LLDP Settings	LLDP ⁴		✓	Page 74
		LLDP-MED Interval timer ⁴		✓	Page 74
		PC	–	–	–
		VLAN ID ⁴		✓	Page 75
		Priority ⁴		✓	Page 75
	VLAN Settings	Enable VLAN ⁴		✓	Page 75
		IP Phone	–	–	–
		VLAN ID ⁴		✓	Page 75
		Priority ⁴		✓	Page 76
		PC	–	–	–
		VLAN ID ⁴		✓	Page 76
		Priority ⁴		✓	Page 75
HTTP Client Settings	HTTP Client Settings	HTTP Version ⁵		✓	Page 77
		HTTP User Agent ⁵		✓	Page 77
	HTTP Authentication	Authentication ID	✓	✓	Page 78
		Authentication Password	✓	✓	Page 78
	Proxy Server Settings	Enable Proxy		✓	Page 78
		Proxy Server Address		✓	Page 79
		Proxy Server Port		✓	Page 79

Section 4 Web User Interface Programming

Menu Item	Section Title	Setting	Access Level ^{*1}		Ref.
			U	A	
Global Address Detection	Global Address Detection	Detection Method		✓	Page 79
		Detection Interval		✓	Page 80
	STUN Server	STUN Server Address ^{*5}		✓	Page 80
		STUN Server Port ^{*5}		✓	Page 80
Static NAPT Settings	Global IP Address	Global IP Address		✓	Page 81
	Enable Global IP Address Usage per Line	Line 1–Line 6		✓	Page 81
	External RTP Port	Channel 1–25		✓	Page 82

^{*1} The access levels are abbreviated as follows:

U: User; A: Administrator

A check mark indicates that the setting is available for that access level.

^{*2} This setting can also be configured through phone user interface programming.

^{*3} If your phone system dealer does not allow you these settings, you cannot change them even though the unit shows the setting menu. Contact your phone system dealer for further information.

^{*4} This setting can also be configured through other programming methods (phone user interface programming or configuration file programming).

^{*5} This setting can also be configured through configuration file programming.

System

Menu Item	Section Title	Setting	Access Level ^{*1}		Ref.
			U	A	
Web Language	Web Language	Language	✓	✓	Page 83
Administrator Password	Change Administrator Password	Current Password ^{*2}		✓	Page 84
		New Password ^{*2}		✓	Page 84
		Confirm New Password ^{*2}		✓	Page 84
Change User Password	Change User Password	Current Password ^{*3}	✓	✓	Page 85
		New Password ^{*3}	✓	✓	Page 85
		Confirm New Password ^{*3}	✓	✓	Page 86
Web Server Settings	Web Server Settings	Web Server Port		✓	Page 86
		Port Close Timer		✓	Page 87

^{*1} The access levels are abbreviated as follows:

U: User; A: Administrator

A check mark indicates that the setting is available for that access level.

^{*2} This setting can also be configured through other programming methods (phone user interface programming or configuration file programming).

^{*3} This setting can also be configured through configuration file programming.

VoIP

Menu Item	Section Title	Setting	Access Level ¹		Ref.
			U	A	
SIP Settings	SIP Setting	SIP User Agent ²		✓	Page 88
SIP Settings [Line 1]–[Line 6]	Phone Number	Phone Number ²		✓	Page 89
		SIP URI ²		✓	Page 89
	SIP Server	Registrar Server Address ²		✓	Page 89
		Registrar Server Port ²		✓	Page 89
		Proxy Server Address ²		✓	Page 90
		Proxy Server Port ²		✓	Page 90
		Presence Server Address ²		✓	Page 90
		Presence Server Port ²		✓	Page 90
	Outbound Proxy Server	Outbound Proxy Server Address ²		✓	Page 91
		Outbound Proxy Server Port ²		✓	Page 91
	SIP Service Domain	Service Domain ²		✓	Page 91
	SIP Source Port	Source Port ²		✓	Page 91
	SIP Authentication	Authentication ID ²		✓	Page 92
		Authentication Password ²		✓	Page 92
	DNS	Enable DNS SRV lookup ²		✓	Page 92
		SRV lookup Prefix for UDP ²		✓	Page 93
		SRV lookup Prefix for TCP ²		✓	Page 93
	Transport Protocol for SIP	Transport Protocol ²		✓	Page 93
	Timer Settings	T1 Timer ²		✓	Page 94
		T2 Timer ²		✓	Page 94
		Timer B ²		✓	Page 94
		Timer D ²		✓	Page 95
		Timer F ²		✓	Page 95
		Timer H ²		✓	Page 95
		Timer J ²		✓	Page 95
	Quality of Service (QoS)	SIP Packet QoS (DSCP) ²		✓	Page 95

Section 4 Web User Interface Programming

Menu Item	Section Title	Setting	Access Level ¹		Ref.
			U	A	
	SIP extensions	Supports 100rel (RFC 3262) ²		✓	Page 96
		Supports Session Timer (RFC 4028) ²		✓	Page 96
	NAT Identity	Keep Alive Interval ²		✓	Page 96
		Supports Rport (RFC 3581) ²		✓	Page 97
	Security	Enable SSAF (SIP Source Address Filter) ²		✓	Page 97
VoIP Settings	RTP Settings	RTP Packet Time ²		✓	Page 98
		Minimum RTP Port Number ²		✓	Page 98
		Maximum RTP Port Number ²		✓	Page 99
		Telephone-event Payload Type ²		✓	Page 99

Menu Item	Section Title	Setting	Access Level ¹		Ref.
			U	A	
VoIP Settings [Line 1]–[Line 6]	Quality of Service (QoS)	RTP Packet QoS (DSCP) ²		✓	Page 100
		RTCP Packet QoS (DSCP) ²		✓	Page 100
	Statistical Information	RTCP Enable ²		✓	Page 101
		RTCP Interval ²		✓	Page 101
	Jitter Buffer	Maximum Delay ²		✓	Page 101
		Minimum Delay ²		✓	Page 101
		Initial Delay ²		✓	Page 102
	DTMF	DTMF Type ²		✓	Page 102
		DTMF Relay ²		✓	Page 102
	Call Hold	Supports RFC 2543 (c=0.0.0.0) ²		✓	Page 103
	CODEC Preferences	G722	–	–	–
		Enable ²		✓	Page 103
		Priority ²		✓	Page 103
		PCMA	–	–	–
		Enable ²		✓	Page 104
		Priority ²		✓	Page 104
		G729A	–	–	–
		Enable ²		✓	Page 104
		Priority ²		✓	Page 104
		PCMU	–	–	–
Enable ²			✓	Page 104	
Priority ²			✓	Page 105	

¹ The access levels are abbreviated as follows:

U: User; A: Administrator

A check mark indicates that the setting is available for that access level.

² This setting can also be configured through configuration file programming.

Telephone

Menu Item	Section Title	Setting	Access Level ¹		Ref.
			U	A	
Call Control	Call Control	Send SUBSCRIBE to Voice Mail Server ²		✓	Page 105
		Conference Server URI ²		✓	Page 106
		Inter-digit Timeout ²		✓	Page 106
		Timer for Dial Plan ²		✓	Page 106
		International Call Prefix ²		✓	Page 106
		Country Calling Code ²		✓	Page 107
		National Access Code ²		✓	Page 107
		Default Line for Outgoing ²	✓	✓	Page 107
		Flash/Recall Button ²		✓	Page 107
		Flash Hook Event ²		✓	Page 108
	Directed Call Pickup ²		✓	Page 108	
	Call Rejection Phone Numbers	1–30	✓	✓	Page 108

Menu Item	Section Title	Setting	Access Level ¹		Ref.
			U	A	
Call Control [Line 1]–[Line 6]	Call Control	Display Name ²	✓	✓	Page 109
		Voice Mail Access Number ²		✓	Page 109
		Enable Shared Call ²		✓	Page 110
		Synchronize Do Not Disturb and Call Forward ²		✓	Page 110
		Resource List URI ²		✓	Page 111
	Dial Plan	Dial Plan (max 500 columns) ²		✓	Page 111
		Call Even If Dial Plan Does Not Match ²		✓	Page 111
	Call Features	Block Caller ID	✓	✓	Page 112
		Block Anonymous Call	✓	✓	Page 112
		Do Not Disturb	✓	✓	Page 113
	Call Forward	Unconditional	–	–	–
		Enable Call Forward	✓	✓	Page 113
		Phone Number	✓	✓	Page 114
		Busy	–	–	–
		Enable Call Forward	✓	✓	Page 114
		Phone Number	✓	✓	Page 115
		No Answer	–	–	–
		Enable Call Forward	✓	✓	Page 115
		Phone Number	✓	✓	Page 116
		Ring Count	✓	✓	Page 116
Tone Settings	Dial Tone	Tone Frequencies ²		✓	Page 117
		Tone Timings ²		✓	Page 117
	Busy Tone	Tone Frequencies ²		✓	Page 118
		Tone Timings ²		✓	Page 118
	Ringing Tone	Tone Frequencies ²		✓	Page 118
		Tone Timings ²		✓	Page 119
	Stutter Tone	Tone Frequencies ²		✓	Page 119
		Tone Timings ²		✓	Page 119
	Reorder Tone	Tone Frequencies ²		✓	Page 120
		Tone Timings ²		✓	Page 120

Section 4 Web User Interface Programming

Menu Item	Section Title	Setting	Access Level ^{*1}		Ref.
			U	A	
Telephone Settings	Telephone Settings	Number Matching Lower Digit ^{*2}		✓	Page 120
		Number Matching Upper Digit ^{*2}		✓	Page 121

^{*1} The access levels are abbreviated as follows:

U: User; A: Administrator

A check mark indicates that the setting is available for that access level.

^{*2} This setting can also be configured through configuration file programming.

Maintenance

Menu Item	Section Title	Setting	Access Level ^{*1}		Ref.
			U	A	
Firmware Maintenance	Firmware Maintenance	Enable Firmware Update ^{*2}		✓	Page 121
		Firmware File URL ^{*2}		✓	Page 122
Provisioning Maintenance	Provisioning Maintenance	Enable Provisioning ^{*2}		✓	Page 123
		Standard File URL ^{*2}		✓	Page 123
		Product File URL ^{*2}		✓	Page 123
		Master File URL ^{*2}		✓	Page 124
		Cyclic Auto Resync ^{*2}		✓	Page 124
		Resync Interval ^{*2}		✓	Page 124
		Header Value for Resync Event ^{*2}		✓	Page 124
Reset to Defaults	Reset Web Data	–		✓	Page 125
Restart	Restart	–		✓	Page 125

^{*1} The access levels are abbreviated as follows:

U: User; A: Administrator

A check mark indicates that the setting is available for that access level.

^{*2} This setting can also be configured through configuration file programming.

4.2 General Information on Web User Interface Programming

4.2.1 Password for Web User Interface Programming

To program the unit via the Web user interface, a login account is required. There are 2 types of accounts, and each has different access privileges.

- **User:** User accounts are for use by end users. Users can change the settings that are specific to the unit.
- **Administrator:** Administrator accounts are for use by administrators to manage the system configuration. Administrators can change all the settings, including the network settings, in addition to the settings that can be changed from a User account.

A separate password is assigned to each account.

For details, see **Access Levels (IDs and Passwords)** in 4.2.3 **Before Accessing the Web User Interface**.

Notice

- You should manage the passwords carefully, and change them regularly.

4.2.2 Changing the Language for Web User Interface Programming

When accessing the unit via the Web user interface on a PC connected to the same network, various menus and settings are displayed. You can change the language used for displaying these setting items. Because the language setting for the Web user interface is not synchronized with those of the unit, you must set the languages for each independently.

For details, see 4.5.1 **Web Language**.

4.2.3 Before Accessing the Web User Interface

Recommended Environment

This unit supports the following specifications:

HTTP Version	HTTP/1.0 (RFC 1945), HTTP/1.1 (RFC 2616)
Authentication Method	Digest (or Basic)

The Web user interface will operate correctly in the following environments:

Operating System	Microsoft Windows® XP or Windows 7 operating system
Web Browser	Windows Internet Explorer® 7 or Windows Internet Explorer 8 web browser
Language (recommended)	English

Note

- Please use a computer rather than the unit for Web user interface programming.

Opening/Closing the Web Port

To access the Web user interface, you must open the unit's Web port beforehand. For details, refer to the Operating Instructions on the Panasonic Web site (→ see **Introduction**).

Configuring Settings from the Unit

To open the unit's Web port

1. Press  on the Home screen, and then tap **[Settings]**.
2. Tap **[Network]** and then select **[Embedded web]**.
3. Tap **[On]**.

To close the unit's Web port

1. Press  on the Home screen, and then tap **[Settings]**.
2. Tap **[Network]** and then select **[Embedded web]**.
3. Tap **[Off]**.

Configuring Settings from the Web User Interface

To close the unit's Web port

1. In the Web user interface, click **[Web Port Close]**.
2. Click **[OK]**.

Note

- The Web port of the unit will be closed automatically in the following conditions:
 - The port close timer configured through the Web user interface expires (→ see **[Port Close Timer]** in **4.5.4.1 Web Server Settings**).
 - 3 consecutive unsuccessful login attempts occur.
- The Web port can be set to stay open continuously, through Configuration file programming (→ see "HTTPD_PORTOPEN_AUTO" in **5.5.2 HTTP Settings**). However, please recognize the possibility of unauthorized access to the unit by doing so.

Access Levels (IDs and Passwords)

2 accounts with different access privileges are provided for accessing the Web user interface: User and Administrator. Each account has its own ID and password, which are required to log in to the Web user interface.

Account	Target User	ID (default)	Password (default)	Password Restrictions
User	End users	user	-blank-(NULL)	<ul style="list-style-type: none"> • When logged in as User, you can change the password for the User account (→ see 4.5.3 Change User Password). • The password can consist of 6 to 16 ASCII characters (case-sensitive) (→ see Entering Characters in 4.2.4 Accessing the Web User Interface).

Account	Target User	ID (default)	Password (default)	Password Restrictions
Administrator	Network administrators, etc.	admin	adminpass	<ul style="list-style-type: none"> When logged in as Administrator, you can change the password for both the User and Administrator accounts (→ see 4.5.2 Administrator Password). The password can consist of 6 to 16 ASCII characters (case-sensitive) (→ see 4.2.4 Accessing the Web User Interface).

Note

- Only one account can be logged in to the Web user interface at a time. If you try to access the Web user interface while someone is logged in, you will be denied access.
- You cannot log in to the Web user interface even under the same account as someone who is already logged in.
- The user password is required to change the settings.
- You can reset the account IDs and passwords to their factory default settings by performing Reset Web ID/Password from the unit. For details, see **3.1.1.2 Reset Web ID/Password**.

4.2.4 Accessing the Web User Interface

The unit can be configured from the Web user interface.

To access the Web user interface

1. Open your Web browser, and then enter "http://" followed by the unit's IP address into the address field of your browser.

Note

- To determine the unit's IP address, perform the following operations on the unit:
 1. Press  **Menu** on the Home screen, and then tap **[Settings]**.
 2. Tap **[About phone]** and then **[Status]**.
 3. Confirm the IP address in **[Network]**.
2. For authentication, enter your ID (username) and password, and then click **[OK]**.

Notice

- When you log in as User to the Web user interface for the first time, the **[Change User Password]** screen (→ see **4.5.3 Change User Password**) will be displayed. Enter a new password, and then perform authentication again with the new password to log in to the Web user interface.

Note

- The default ID for the User account is "user", and the default password is blank. The ID cannot be changed from the Web user interface, but it can be changed through configuration file programming.

- The default ID for the Administrator account is "admin", and the default password is "adminpass". The ID cannot be changed from the Web user interface, but it can be changed through configuration file programming.
3. The Web user interface window is displayed. Configure the settings for the unit as desired.
 4. You can log out from the Web user interface at any time by clicking [**Web Port Close**].

Controls on the Window

The Web user interface window contains various controls for navigating and configuring settings. The following figure shows the controls that are displayed on the [**Basic Network Settings**] screen as an example:

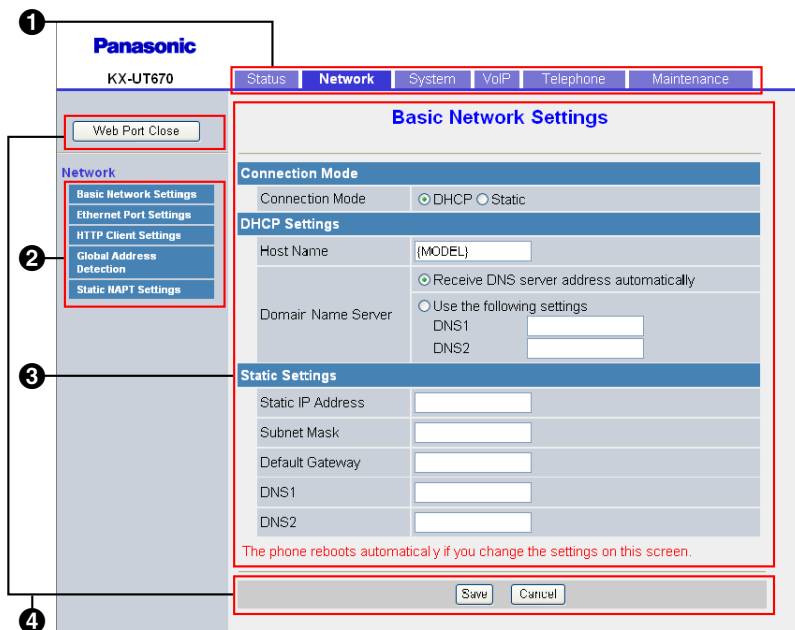

Note

- Actual default values may vary depending on your phone system dealer.
- When you log in to the Web user interface with the User account, the languages of messages displayed on the configuration screen may differ depending on the country/area of use.

1 Tabs

Tabs are the top categories for classifying settings. When you click a tab, the corresponding menu items and the configuration screen of the first menu item appear. There are 6 tabs for the Administrator account and 4 tabs for the User account. For details about the account types, see **Access Levels (IDs and Passwords)** in this section.

2 Menu

The menu displays the sub-categories of the selected tab.

3 Configuration Screen

Clicking a menu displays the corresponding configuration screen, which contains the actual settings, grouped into sections. For details, see **4.3 Status** to **4.8.4 Restart**.

4 Buttons

The following standard buttons are displayed in the Web user interface:

Button	Function
Web Port Close	Closes the Web port of the unit and logs you out of the Web user interface after a confirmation message is displayed.

Button	Function
Save	Applies changes and displays a result message (→ see 4.9 Result Messages in this section).
Cancel	Discards changes. The settings on the current screen will return to the values they had before being changed.
Refresh	Updates the status information displayed on the screen. This button is displayed in the upper-right area of the [Network Status] and [VoIP Status] screens.

Entering Characters

In the Web user interface, when specifying a name, message, password, or other text item, you can enter any of the ASCII characters displayed in the following table with a white background.

	00	01	02	03	04	05	06	07	08	09	0A	0B	0C	0D	0E	0F
20	SP	!	"	#	\$	%	&	'	()	*	+	,	-	.	/
30	0	1	2	3	4	5	6	7	8	9	:	;	<	=	>	?
40	@	A	B	C	D	E	F	G	H	I	J	K	L	M	N	O
50	P	Q	R	S	T	U	V	W	X	Y	Z	[\]	^	_
60	`	a	b	c	d	e	f	g	h	i	j	k	l	m	n	o
70	p	q	r	s	t	u	v	w	x	y	z	{		}	~	

However, there are additional limitations for certain types of fields as follows:

- Number field
 - You may only enter a sequence of numeric characters.
 - You cannot leave the field empty.
- IP Address field
 - You can enter the IP address using dotted-decimal notation (i.e., "n.n.n.n" where n=0–255).
 - You cannot enter invalid IP addresses, for example, "0.0.0.0", "255.255.255.255", or "127.0.0.1".
- FQDN field
 - The field cannot contain ", &, ', <, >, or trailing spaces.
 - You can enter the IP address using dotted-decimal notation (i.e., "n.n.n.n" where n=0–255).
 - You cannot enter invalid IP addresses, for example, "0.0.0.0", "255.255.255.255", or "127.0.0.1".
- Authentication ID/Password field
 - The field cannot contain ", &, ', :, <, >, or space.
 - The length of user password and administrator password must be from 6 to 16 characters.
- Display Name field (→ see **[Display Name]** in **4.7.2.1 Call Control**)
 - This is the only field in which you can enter Unicode characters.

4.3 Status

This section provides detailed descriptions about all the settings classified under the **[Status]** tab.

4.3.1 Version Information

This screen allows you to view the current version information such as the model number and the firmware version of the unit.

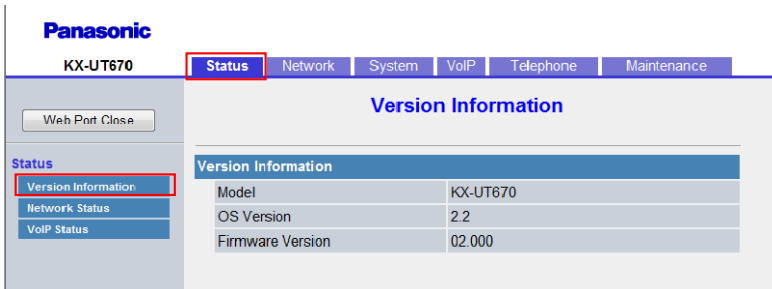

4.3.1.1 Version Information

Model

Description	Indicates the model number of the unit (reference only).
--------------------	--

OS Version

Description	Indicates the software version that is currently installed on the unit (reference only).
--------------------	--

Firmware Version

Description	Indicates the version of the firmware that is currently installed on the unit (reference only).
--------------------	---

4.3.2 Network Status

This screen allows you to view the current network information of the unit, such as the MAC address, IP address, Ethernet port status, etc.

Clicking **[Refresh]** updates the information displayed on the screen.

The screenshot shows the Panasonic KX-UT670 web interface. The 'Status' tab is selected, and the 'Network Status' section is highlighted. The page displays various network parameters such as MAC Address, Ethernet Link Status (LAN Port), Ethernet Link Status (PC Port), Connection Mode, IP Address, Subnet Mask, Default Gateway, DNS1, and DNS2. A 'Refresh' button is visible in the top right corner of the Network Status section.

4.3.2.1 Network Status

MAC Address

Description	Indicates the MAC address of the unit (reference only).
--------------------	---

Ethernet Link Status (LAN Port)

Description	Indicates the current connection status of the Ethernet LAN port (reference only).
--------------------	--

Ethernet Link Status (PC Port)

Description	Indicates the current connection status of the Ethernet PC port (reference only).
--------------------	---

Connection Mode

Description	Indicates whether the IP address of the unit is assigned automatically (DHCP) or manually (static) (reference only).
--------------------	--

IP Address

Description	Indicates the currently assigned IP address of the unit (reference only).
--------------------	---

Subnet Mask

Description	Indicates the specified subnet mask for the unit (reference only).
--------------------	--

Default Gateway

Description	Indicates the specified IP address of the default gateway for the network (reference only). Note <ul style="list-style-type: none"> If the default gateway address is not specified, this field will be left blank.
--------------------	--

DNS1

Description	Indicates the specified IP address of the primary DNS server (reference only). Note <ul style="list-style-type: none"> If the primary DNS server address is not specified, this field will be left blank.
--------------------	--

DNS2

Description	Indicates the specified IP address of the secondary DNS server (reference only). Note <ul style="list-style-type: none"> If the secondary DNS server address is not specified, this field will be left blank.
--------------------	--

4.3.3 VoIP Status

This screen allows you to view the current VoIP status of each line's unit. Clicking **[Refresh]** updates the information displayed on the screen.



4.3.3.1 VoIP Status

Line No.

Description	Indicates the line number to which a phone number is assigned (reference only).
--------------------	---

Phone Number

Description	Indicates the currently assigned phone numbers (reference only). Note <ul style="list-style-type: none"> The corresponding field is blank if a line has not yet been leased or if the unit has not been configured.
--------------------	--

VoIP Status

Description	Indicates the current VoIP status of each line (reference only).
Value Range	<ul style="list-style-type: none"> Registered: The unit has been registered to the SIP server, and the line can be used. Registering: The unit is being registered to the SIP server, and the line cannot be used. Blank: The line has not been leased, the unit has not been configured yet, or a SIP authentication failure has occurred. Note <ul style="list-style-type: none"> The status of the line may not be displayed immediately after starting up the unit because the unit is still being registered to the SIP server. To display the status, wait about 2 to 2.5 minutes, and then click [Refresh] to obtain updated status information.

4.4 Network

This section provides detailed descriptions about all the settings classified under the **[Network]** tab.

4.4.1 Basic Network Settings

This screen allows you to change basic network settings such as whether to use a DHCP server, and the IP address of the unit.

Note

- When you change the settings on this screen and click **[Save]**, the message "Complete" is displayed, and then the unit will restart automatically even if the unit is on a call.
- Since the IP address of the unit will probably be changed if you change these settings, you will not be able to continue using the Web user interface. To continue configuring the unit from the Web user interface, log in to the Web user interface again after confirming the newly assigned IP address of the

unit using the phone user interface. In addition, if the IP address of the PC from which you try to access the Web user interface has been changed, close the Web port once by selecting **[Off]** for **[Embedded web]** on the unit (→ see **Opening/Closing the Web Port** in **4.2.3 Before Accessing the Web User Interface**).

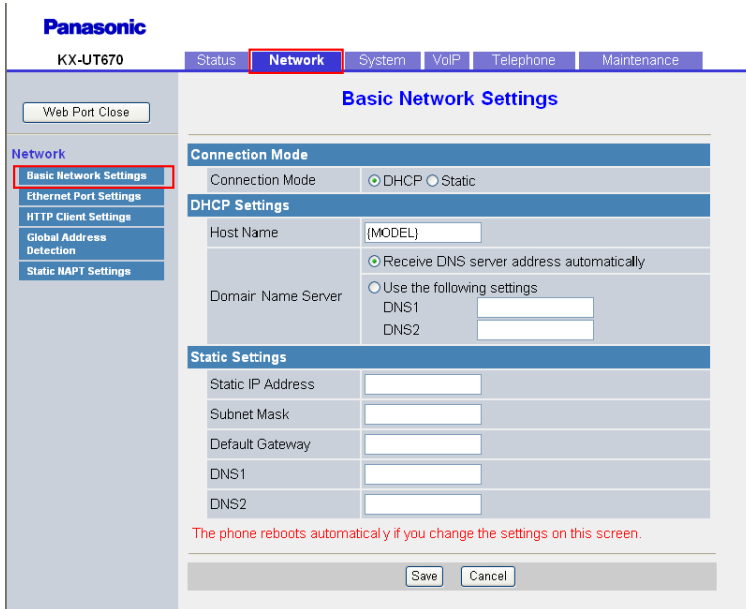

4.4.1.1 Connection Mode

Connection Mode

Description	Selects whether to assign the IP address automatically (DHCP) or manually (static).
Value Range	<ul style="list-style-type: none"> DHCP Static
Default Value	DHCP
Phone User Interface Reference	Network Settings (Page 16)

4.4.1.2 DHCP Settings

Host Name

Description	Specifies the host name for the unit to send to the DHCP server.
	<p>Note</p> <ul style="list-style-type: none"> This setting is available only when [Connection Mode] is set to [DHCP].

Value Range	Max. 63 characters Note <ul style="list-style-type: none"> You cannot leave this field empty. If "{MODEL}" is included in this parameter, it will be replaced with the unit's model name.
Default Value	{MODEL}

Domain Name Server

Description	Selects whether to receive DNS server addresses automatically or to assign a DNS server addresses (up to 2) manually. Note <ul style="list-style-type: none"> This setting is available only when [Connection Mode] is set to [DHCP].
Value Range	<ul style="list-style-type: none"> Receive DNS server address automatically Use the following settings <ul style="list-style-type: none"> DNS1 DNS2 Note <ul style="list-style-type: none"> If you select [Use the following settings], specify the IP address(es) of the primary and, if necessary, secondary DNS server(s) manually.
Default Value	Receive DNS server address automatically
Phone User Interface Reference	Network Settings (Page 16)

4.4.1.3 Static Settings

Static IP Address

Description	Specifies the IP address for the unit. Note <ul style="list-style-type: none"> This setting is available only when [Connection Mode] is set to [Static].
Value Range	Max. 15 characters
Default Value	Not stored.
Phone User Interface Reference	Network Settings (Page 16)

Subnet Mask

Description	Specifies the subnet mask for the unit. Note <ul style="list-style-type: none"> This setting is available only when [Connection Mode] is set to [Static].
Value Range	Max. 15 characters
Default Value	Not stored.
Phone User Interface Reference	Network Settings (Page 16)

Default Gateway

Description	Specifies the IP address of the default gateway for the network where the unit is connected. Note <ul style="list-style-type: none"> This setting is available only when [Connection Mode] is set to [Static].
Value Range	Max. 15 characters
Default Value	Not stored.
Phone User Interface Reference	Network Settings (Page 16)

DNS1

Description	Specifies the IP address of the primary DNS server. Note <ul style="list-style-type: none"> This setting is available only when [Connection Mode] is set to [Static].
Value Range	Max. 15 characters
Default Value	Not stored.
Phone User Interface Reference	Network Settings (Page 16)

DNS2

Description	Specifies the IP address of the secondary DNS server. Note <ul style="list-style-type: none"> This setting is available only when [Connection Mode] is set to [Static].
--------------------	--

Value Range	Max. 15 characters
Default Value	Not stored.
Phone User Interface Reference	Network Settings (Page 16)

4.4.2 Ethernet Port Settings

This screen allows you to change the connection mode of the Ethernet ports, the LLDP settings and the VLAN settings.

Note

- When you change the settings on this screen and click **[Save]**, the message "Complete" is displayed, and then the unit will restart automatically even if the unit is on a call.
- Incorrect settings may cause a network failure. In such a case, you cannot access the Web user interface anymore. To access it again, you need to correct the speed/duplex settings or perform IP Reset through phone user interface programming. For details, refer to the Operating Instructions on the Panasonic Web site (→ see **Introduction**).

Panasonic
KX-UT670 | Status | **Network** | System | VoIP | Telephone | Maintenance

Web Port Close

Network

- Basic Network Settings
- Ethernet Port Settings**
- HTTP Client Settings
- Global Address Detection
- Static NAT Settings

Ethernet Port Settings

Link Speed/Duplex Mode

LAN Port: Auto Negotiation

PC Port: Auto Negotiation

LLDP Settings

Enable LLDP: Yes No

LLDP-MED Interval timer: 30 seconds [1-3600]

IP Phone: VLAN ID: ----, Priority: -

PC: VLAN ID: 0 [0-4094], Priority: 0

VLAN Settings

Enable VLAN: Yes No

IP Phone: VLAN ID: 2 [1-4094], Priority: 7

PC: VLAN ID: 1 [1-4094], Priority: 0

The phone reboots automatically if you change the settings on this screen.

Save Cancel

4.4.2.1 Link Speed/Duplex Mode

LAN Port

Description	Selects the connection mode (link speed and duplex mode) of the LAN port.
--------------------	---

Value Range	<ul style="list-style-type: none"> • Auto Negotiation • 100 Mbps/Full Duplex • 100 Mbps/Half Duplex • 10 Mbps/Full Duplex • 10 Mbps/Half Duplex
Default Value	Auto Negotiation
Phone User Interface Reference	Ethernet Settings (Page 17)

PC Port

Description	Selects the connection mode (link speed and duplex mode) of the PC port.
Value Range	<ul style="list-style-type: none"> • Auto Negotiation • 100 Mbps/Full Duplex • 100 Mbps/Half Duplex • 10 Mbps/Full Duplex • 10 Mbps/Half Duplex
Default Value	Auto Negotiation
Phone User Interface Reference	Ethernet Settings (Page 17)

4.4.2.2 LLDP Settings

LLDP

Description	Selects whether to enable or disable sending and receiving LLDP frames.
Value Range	<ul style="list-style-type: none"> • Yes • No
Default Value	Yes
Phone User Interface Reference	Ethernet Settings (Page 17)
Configuration File Reference	LLDP_ENABLE (Page 151)

LLDP-MED Interval timer

Description	Specifies the interval, in seconds, between sending each LLDP frame.
Value Range	1–3600
Default Value	30
Phone User Interface Reference	Ethernet Settings (Page 17)

Configuration File Reference	LLDP_INTERVAL (Page 152)
-------------------------------------	--------------------------

PC (VLAN ID)

Description	Specifies the VLAN ID of the PC port when the LLDP feature is enabled.
Value Range	0–4094
Default Value	0
Phone User Interface Reference	Ethernet Settings (Page 17)
Configuration File Reference	LLDP_VLAN_ID_PC (Page 152)

PC (Priority)

Description	Specifies the VLAN Priority of the PC port when the LLDP feature is enabled.
Value Range	0–7
Default Value	0
Phone User Interface Reference	Ethernet Settings (Page 17)
Configuration File Reference	LLDP_VLAN_PRI_PC (Page 152)

4.4.2.3 VLAN Settings

Enable VLAN

Description	Selects whether to use the VLAN feature to perform VoIP communication securely.
Value Range	<ul style="list-style-type: none"> • Yes • No
Default Value	No
Phone User Interface Reference	Ethernet Settings (Page 17)
Configuration File Reference	LLDP_ENABLE (Page 151)

IP Phone (VLAN ID)

Description	Specifies the VLAN ID for this unit.
Value Range	1–4094
Default Value	2

Phone User Interface Reference	Ethernet Settings (Page 17)
Configuration File Reference	VLAN_ID_IP_PHONE (Page 153)

IP Phone (Priority)

Description	Selects the priority number for the unit.
Value Range	0–7
Default Value	7
Phone User Interface Reference	Ethernet Settings (Page 17)
Configuration File Reference	VLAN_PRI_IP_PHONE (Page 153)

PC (VLAN ID)

Description	Specifies the VLAN ID for the PC.
Value Range	1–4094
Default Value	1
Phone User Interface Reference	Ethernet Settings (Page 17)
Configuration File Reference	VLAN_ID_PC (Page 154)

PC (Priority)

Description	Selects the priority number for the PC.
Value Range	0–7
Default Value	0
Phone User Interface Reference	Ethernet Settings (Page 17)
Configuration File Reference	VLAN_PRI_PC (Page 154)

4.4.3 HTTP Client Settings

This screen allows you to change the HTTP client settings for the unit. Configure proxy settings as necessary, according to your network setup. The proxy server is used when accessing the HTTP server of your phone system, downloading configuration files, and when using the unit's Web browser.

The screenshot shows the Panasonic KX-UT670 Web User Interface. The 'Network' tab is selected. The 'HTTP Client Settings' page is displayed, featuring a sidebar with navigation options like 'Basic Network Settings', 'Ethernet Port Settings', 'HTTP Client Settings', 'Global Address Detection', and 'Static IAPT Settings'. The main content area is titled 'HTTP Client Settings' and contains three sections: 'HTTP Client Settings' with radio buttons for 'HTTP/1.0' and 'HTTP/1.1', a text field for 'HTTP User Agent', 'HTTP Authentication' with text fields for 'Authentication ID' and 'Authentication Password', and 'Proxy Server Settings' with a radio button for 'Enable Proxy', a text field for 'Proxy Server Address', and a text field for 'Proxy Server Port' with a default value of 8080 and a range indicator [1-65535]. 'Save' and 'Cancel' buttons are at the bottom.

4.4.3.1 HTTP Client Settings

HTTP Version

Description	Selects which version of the HTTP protocol to use for HTTP communication.
Value Range	<ul style="list-style-type: none"> HTTP/1.0 HTTP/1.1 <p>Note</p> <ul style="list-style-type: none"> For this unit, it is strongly recommended that you select [HTTP/1.0]. However, if the HTTP server does not function well with HTTP/1.0, try changing the setting [HTTP/1.1].
Default Value	HTTP/1.0
Configuration File Reference	HTTP_VER (Page 155)

HTTP User Agent

Description	Specifies the text string to send as the user agent in the header of HTTP requests.
--------------------	---

Value Range	Max. 40 characters Note <ul style="list-style-type: none"> You cannot leave this field empty. If "{mac}" is included in this field, it will be replaced with the unit's MAC address in lower-case. If "{MAC}" is included in this field, it will be replaced with the unit's MAC address in upper-case. If "{MODEL}" is included in this field, it will be replaced with the unit's model name. If "{fwver}" is included in this field, it will be replaced with the firmware version of the unit.
Default Value	Panasonic_{MODEL}/{fwver} ({mac})
Configuration File Reference	HTTP_USER_AGENT (Page 155)

4.4.3.2 HTTP Authentication

Authentication ID

Description	Specifies the ID for the User account. If set, this name must be entered to access the Web user interface at the User access level.
Value Range	Max. 127 characters
Default Value	Not stored.

Authentication Password

Description	Specifies the password for the User account. If set, this password must be entered to access the Web user interface at the User access level.
Value Range	Max. 127 characters
Default Value	Not stored.

4.4.3.3 Proxy Server Settings

Enable Proxy

Description	Selects whether to use the proxy server. Note <ul style="list-style-type: none"> The unit's Web server proxy settings are also used for provisioning and updating the firmware.
Value Range	<ul style="list-style-type: none"> Yes No
Default Value	No

Proxy Server Address

Description	Specifies the IP address or FQDN of the proxy server.
Value Range	Max. 127 characters Note <ul style="list-style-type: none"> You cannot leave this field empty if [Enable Proxy] is set to [Yes].
Default Value	Not stored.

Proxy Server Port

Description	Specifies the port number of the proxy server.
Value Range	1–65535
Default Value	8080

4.4.4 Global Address Detection

This screen allows you to configure the Global Address Detection feature and STUN server settings. The global IP address of the network the unit is connected to will be detected periodically. If the global IP address has changed, the new address will be registered to the SIP server.

Note

- If the unit is connected directly to the Internet, or the network global address is static (i.e., does not change), you do not need to configure Global Address Detection.

The screenshot shows the Panasonic KX-UT670 web interface. The top navigation bar includes 'Status', 'Network' (highlighted), 'System', 'VoIP', 'Telephone', and 'Maintenance'. The main content area is titled 'Global Address Detection'. On the left, there is a sidebar with 'Network' settings, including 'Basic Network Settings', 'Ethernet Port Settings', 'HTTP Client Settings', 'Global Address Detection' (highlighted with a red box), and 'Static NAPT Settings'. The main configuration area has two sections: 'Global Address Detection' and 'STUN Server'. In the 'Global Address Detection' section, 'Detection Method' has radio buttons for 'STUN' (selected) and 'SIP', and 'Detection Interval' is set to 0 seconds. In the 'STUN Server' section, 'STUN Server Address' is set to 0 and 'STUN Server Port' is set to 3478. At the bottom, there are 'Save' and 'Cancel' buttons.

4.4.4.1 Global Address Detection

Detection Method

Description	Selects the method to use for detecting the global IP address.
Value Range	<ul style="list-style-type: none"> STUN SIP

Default Value	STUN
---------------	------

Detection Interval

Description	Specifies the interval, in seconds, to wait between attempts to detect the global IP address.
Value Range	0, 10–65535 (0: Disable) Note <ul style="list-style-type: none"> When [Detection Method] is set to [SIP], the value "0" disables detection and a value other than "0" enables detection.
Default Value	0

4.4.4.2 STUN Server

STUN Server Address

Description	Specifies the IP address or FQDN of the STUN server.
Value Range	Max. 127 characters
Default Value	Not stored.
Configuration File Reference	STUN_SERV_ADDR (Page 157)

STUN Server Port

Description	Specifies the port number of the STUN server.
Value Range	1–65535
Default Value	3478
Configuration File Reference	STUN_SERV_PORT (Page 158)

4.4.5 Static NAPT Settings

This screen allows you to configure the NAPT (Network Address Port Translation) settings. If the unit is connected behind a router that uses NAT/NAPT to translate between private and global IP addresses, VoIP

packets might be blocked by the router, depending on the SIP server. To avoid this problem, this setting is required. For details, see **1.1.4.2 NAT (Network Address Translation) Setup**.

4.4.5.1 Global IP Address

Global IP Address

Description	Specifies the global IP address of your network. Note <ul style="list-style-type: none"> You must enter a value in this field if at least 1 of [Line 1]–[Line 6] is set to [Yes], or when port numbers are specified in [Channel 1–25]. The global IP address will reflect SIP messages and RTP packets.
Value Range	IP address in dotted-decimal notation ("n.n.n.n" [n=0–255]) (Max. 15 digits)
Default Value	Not stored.

4.4.5.2 Enable Global IP Address Usage per Line

Line 1–Line 6

Description	Selects whether to enable the NAT Traversal feature for each line.
Value Range	<ul style="list-style-type: none"> Yes No

Default Value	No
---------------	----

4.4.5.3 External RTP Port

Channel 1–25

Description	Specifies the external RTP port number used for voice communication for each channel.
Value Range	0, 1024–49150 (0: Disable, even number only) Note <ul style="list-style-type: none"> • Each channel must be set to a unique port number, and all port numbers must be an even number. • You cannot specify here the same port number as any of the port numbers specified for the individual lines in [Source Port] in 4.6.2.5 SIP Source Port. In addition, you cannot specify a port number that is 1 less than a port number specified in [Source Port] if the source port number is an odd number. • All channels must be enabled or all channels must be disabled, at the same time.
Default Value	0

4.5 System

This section provides detailed descriptions about all the settings classified under the **[System]** tab.

4.5.1 Web Language

This screen allows you to select the language used for the Web user interface. The language setting is only applicable when you log in to the Web user interface as User.

Note

- If you change the language while logged in to the Web user interface with the User account, the language will be changed after the message "Complete" is displayed. If you are logged in with the Administrator account, the language will be changed when a user logs in to the Web user interface as User.
- The language used for the Web user interface for the Administrator account is always English.

- The language used for the unit remains unchanged even if the language for the Web user interface is changed.

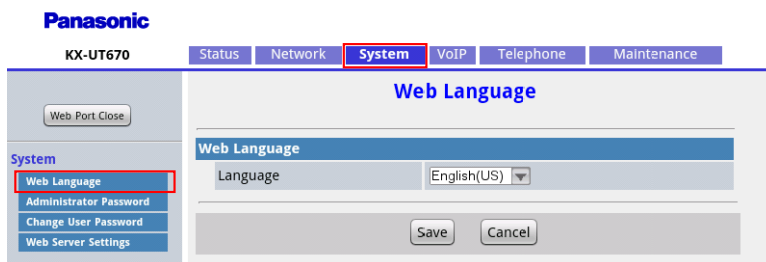

4.5.1.1 Web Language

Language

Description	Selects the language used for the Web user interface.
Value Range	<ul style="list-style-type: none"> • English (US) • English (UK) • Deutsch • Français • Español • Italiano • Русский • 日本語
Default Value	English (US)

4.5.2 Administrator Password

This screen allows you to change the password used to authenticate the Administrator account when logging in to the Web user interface.

Note

- For security reasons, the characters entered for the password are masked by special characters, which differ depending on the Web browser.
- After you change the administrator password, the next time you access the Web user interface, the authentication dialog box appears. Two consecutive login failures will result in an error ("401

Unauthorized"). This restriction only applies the first time you attempt to log in after changing the password. In all other circumstances, an error occurs after 3 unsuccessful login attempts.

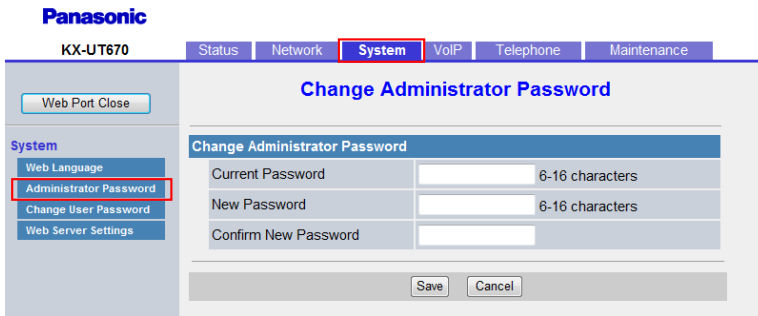

4.5.2.1 Change Administrator Password

Current Password

Description	Specifies the current password to use to authenticate the Administrator account when logging in to the Web user interface.
Value Range	6–16 characters (except ", &, ', :, <, >, and space)
Default Value	adminpass
Phone User Interface Reference	To change the administrator password (Page 49)
Configuration File Reference	ADMIN_PASS (Page 140)

New Password

Description	Specifies the new password to use to authenticate the Administrator account when logging in to the Web user interface.
Value Range	6–16 characters (except ", &, ', :, <, >, and space)
Default Value	Not stored.
Phone User Interface Reference	To change the administrator password (Page 49)
Configuration File Reference	ADMIN_PASS (Page 140)

Confirm New Password

Description	Specifies the same password that you entered in [New Password] for confirmation.
Value Range	6–16 characters (except ", &, ', :, <, >, and space) Note <ul style="list-style-type: none"> This value must be the same as the value entered in [New Password].

Default Value	Not stored.
Phone User Interface Reference	To change the administrator password (Page 49)
Configuration File Reference	ADMIN_PASS (Page 140)

4.5.3 Change User Password

This screen allows you to change the password used to authenticate the User account when logging in to the Web user interface.

Note

- For security reasons, the characters entered for the password are masked by special characters, which differ depending on the Web browser.
- After you change the user password, the next time you access the Web user interface, the authentication dialog box appears. Two consecutive login failures will result in an error ("401 Unauthorized"). This restriction only applies the first time you attempt to log in after changing the password. In all other circumstances, an error occurs after 3 unsuccessful login attempts.

4.5.3.1 Change User Password

Current Password

Description	Specifies the current password to use to authenticate the User account when logging in to the Web user interface.
Value Range	6–16 characters (except ", &, ', :, <, >, and space)
Default Value	Not stored.
Configuration File Reference	USER_PASS (Page 140)

New Password

Description	Specifies the new password to use to authenticate the User account when logging in to the Web user interface.
Value Range	6–16 characters (except ", &, ', :, <, >, and space)

Default Value	Not stored. Note <ul style="list-style-type: none"> When a user logs in to the Web user interface for the first time, after clicking OK on the authentication dialog box, the [Change User Password] screen is displayed automatically to make the user set a password.
Configuration File Reference	USER_PASS (Page 140)

Confirm New Password

Description	Specifies the same password that you entered in [New Password] for confirmation.
Value Range	6–16 characters (except ", &, ', :, <, >, and space) Note <ul style="list-style-type: none"> This value must be the same as the value entered in [New Password].
Default Value	Not stored.
Configuration File Reference	USER_PASS (Page 140)

4.5.4 Web Server Settings

This screen allows you to change the Web server settings.

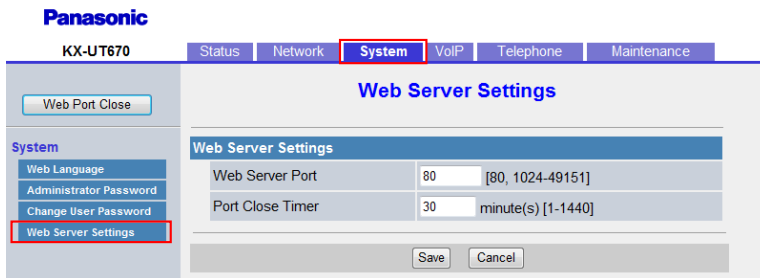

4.5.4.1 Web Server Settings

Web Server Port

Description	Specifies the port number used by the Web server.
Value Range	80, 1024–49151 Note <ul style="list-style-type: none"> You cannot specify here the same port number as any of the port numbers specified for the individual lines in [Source Port] in 4.6.2.5 SIP Source Port.

Default Value	80 Note <ul style="list-style-type: none"> When you change the default value of the port number to a value other than "80", such as "8080", enter the URL for accessing the Web user interface using the following format: "http://192.168.0.100:8080/" (192.168.0.100: IP address of the unit)
----------------------	--

Port Close Timer

Description	Specifies the length of time, in minutes, to keep the Web port open when there has been no communication between the unit and the PC. If the specified length of time elapses without any communication, the Web port closes automatically. Communication is detected when you click a tab, menu item, the [Save] button, or by reloading the application or pressing the F5 key.
Value Range	1–1440
Default Value	30

4.6 VoIP

This section provides detailed descriptions about all the settings classified under the **[VoIP]** tab.

4.6.1 SIP Settings

This screen allows you to change the SIP settings that are common to all lines.

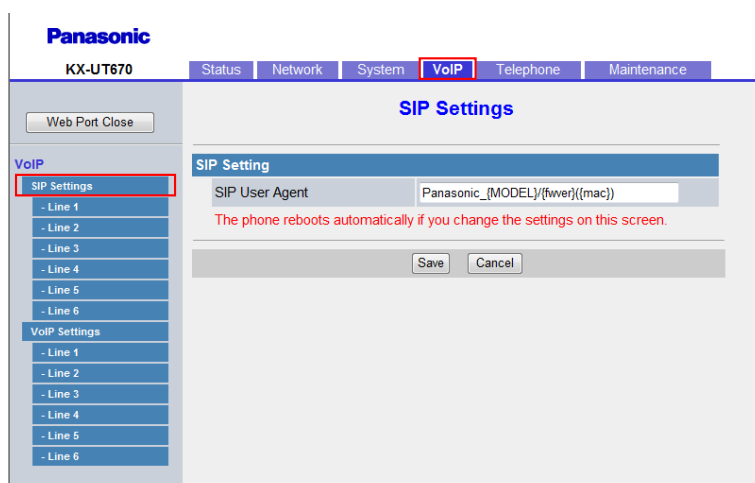

4.6.1.1 SIP Setting

SIP User Agent

Description	Specifies the text string to send as the user agent in the headers of SIP messages.
Value Range	Max. 40 characters Note <ul style="list-style-type: none"> You cannot leave this field empty. If "{mac}" is included in this field, it will be replaced with the unit's MAC address in lower-case. If "{MAC}" is included in this field, it will be replaced with the unit's MAC address in upper-case. If "{MODEL}" is included in this field, it will be replaced with the unit's model name. If "{fwver}" is included in this field, it will be replaced with the firmware version of the unit.
Default Value	Panasonic_{MODEL}/{fwver} ({mac})
Configuration File Reference	SIP_USER_AGENT (Page 188)

4.6.2 SIP Settings [Line 1]–[Line 6]

This screen allows you to change the SIP settings that are specific to each line.

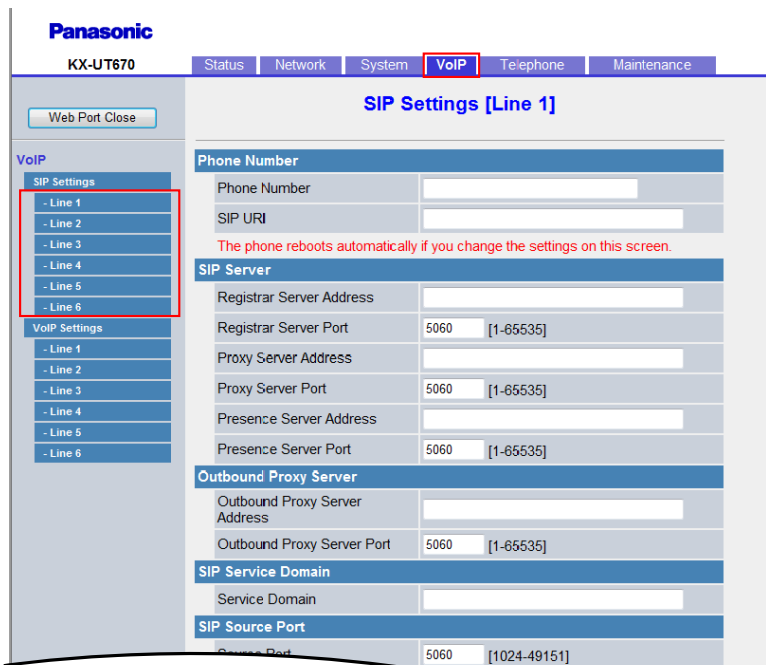

4.6.2.1 Phone Number

Phone Number

Description	Specifies the phone number to use as the user ID required for registration to the SIP registrar server. Note <ul style="list-style-type: none"> When registering using a user ID that is not a phone number, you should use the [SIP URI] setting.
Value Range	Max. 32 characters
Default Value	Not stored.
Configuration File Reference	PHONE_NUMBER_n (Page 189)

SIP URI

Description	Specifies the unique ID used by the SIP registrar server, which consists of "sip:", a user part, the "@" symbol, and a host part, for example, "sip:user@example.com". Note <ul style="list-style-type: none"> When registering using a user ID that is not a phone number, you should use this setting. In a SIP URI, the user part ("user" in the example above) can contain up to 63 characters, and the host part ("example.com" in the example above) can contain up to 127 characters.
Value Range	Max. 195 characters (except ", &, ', :, ;, <, >, and space)
Default Value	Not stored.
Configuration File Reference	SIP_URI_n (Page 189)

4.6.2.2 SIP Server

Registrar Server Address

Description	Specifies the IP address or FQDN of the SIP registrar server.
Value Range	Max. 127 characters
Default Value	Not stored.
Configuration File Reference	SIP_RGSTR_ADDR_n (Page 191)

Registrar Server Port

Description	Specifies the port number to use for communication with the SIP registrar server.
--------------------	---

Value Range	1–65535
Default Value	5060
Configuration File Reference	SIP_RGSTR_PORT_n (Page 192)

Proxy Server Address

Description	Specifies the IP address or FQDN of the SIP proxy server.
Value Range	Max. 127 characters
Default Value	Not stored.
Configuration File Reference	SIP_PRXY_ADDR_n (Page 191)

Proxy Server Port

Description	Specifies the port number to use for communication with the SIP proxy server.
Value Range	1–65535
Default Value	5060
Configuration File Reference	SIP_PRXY_PORT_n (Page 191)

Presence Server Address

Description	Specifies the IP address or FQDN of the SIP presence server.
Value Range	Max. 127 characters
Default Value	Not stored.
Configuration File Reference	SIP_PRSNC_ADDR_n (Page 199)

Presence Server Port

Description	Specifies the port number to use for communication with the SIP presence server.
Value Range	1–65535
Default Value	5060
Configuration File Reference	SIP_PRSNC_PORT_n (Page 199)

4.6.2.3 Outbound Proxy Server

Outbound Proxy Server Address

Description	Specifies the IP address or FQDN of the SIP outbound proxy server.
Value Range	Max. 127 characters
Default Value	Not stored.
Configuration File Reference	SIP_OUTPROXY_ADDR_n (Page 204)

Outbound Proxy Server Port

Description	Specifies the port number to use for communication with the SIP outbound proxy server.
Value Range	1–65535
Default Value	5060
Configuration File Reference	SIP_OUTPROXY_PORT_n (Page 205)

4.6.2.4 SIP Service Domain

Service Domain

Description	Specifies the domain name provided by your phone system dealer. The domain name is the part of the SIP URI that comes after the "@" symbol.
Value Range	Max. 127 characters
Default Value	Not stored.
Configuration File Reference	SIP_SVCDOMAIN_n (Page 192)

4.6.2.5 SIP Source Port

Source Port

Description	Specifies the source port number used by the unit for SIP communication.
--------------------	--

Value Range	1024–49151 Note <ul style="list-style-type: none"> You cannot specify here the same port number as any of the port numbers in [Channel 1–25] in 4.4.5.3 External RTP Port (if they are configured). In addition, you cannot specify a port number that is 1 greater than a port number specified in [Channel 1–25]. The SIP port number for each line must be unique. You cannot specify the same port number as the port number specified in [Web Server Port] in 4.5.4.1 Web Server Settings.
Default Value	5060 (for Line 1) 5070 (for Line 2) 5080 (for Line 3) 5090 (for Line 4) 5100 (for Line 5) 5110 (for Line 6)
Configuration File Reference	SIP_SRC_PORT_n (Page 191)

4.6.2.6 SIP Authentication

Authentication ID

Description	Specifies the authentication ID required to access the SIP server.
Value Range	Max. 64 characters (except ", &, ', :, <, >, and space)
Default Value	Not stored.
Configuration File Reference	SIP_AUTHID_n (Page 190)

Authentication Password

Description	Specifies the authentication password used to access the SIP server.
Value Range	Max. 64 characters (except ", &, ', :, <, >, and space)
Default Value	Not stored.
Configuration File Reference	SIP_PASS_n (Page 190)

4.6.2.7 DNS

Enable DNS SRV lookup

Description	Selects whether to request the DNS server to translate domain names into IP addresses using the SRV record.
--------------------	---

Value Range	<ul style="list-style-type: none"> • Yes • No <p>Note</p> <ul style="list-style-type: none"> • If you select [Yes], the unit will perform a DNS SRV lookup for a SIP registrar server, SIP proxy server, SIP outbound proxy server, or SIP presence server. If you select [No], the unit will not perform a DNS SRV lookup for a SIP registrar server, SIP proxy server, SIP outbound proxy server, or SIP presence server.
Default Value	Yes
Configuration File Reference	SIP_DNSSRV_ENA_n (Page 197)

SRV lookup Prefix for UDP

Description	Specifies a prefix to add to the domain name when performing a DNS SRV lookup using UDP.
	<p>Note</p> <ul style="list-style-type: none"> • This setting is available only when [Enable DNS SRV lookup] is set to [Yes].
Value Range	Max. 32 characters
Default Value	_sip._udp.
Configuration File Reference	SIP_UDP_SRV_PREFIX_n (Page 197)

SRV lookup Prefix for TCP

Description	Specifies a prefix to add to the domain name when performing a DNS SRV lookup using TCP.
	<p>Note</p> <ul style="list-style-type: none"> • This setting is available only when [Enable DNS SRV lookup] is set to [Yes].
Value Range	Max. 32 characters
Default Value	_sip._tcp.
Configuration File Reference	SIP_TCP_SRV_PREFIX_n (Page 198)

4.6.2.8 Transport Protocol for SIP

Transport Protocol

Description	Selects which transport layer protocol to use for sending SIP packets.
--------------------	--

Value Range	<ul style="list-style-type: none"> • UDP • TCP
Default Value	UDP
Configuration File Reference	SIP_TRANSPORT_n (Page 205)

4.6.2.9 Timer Settings

T1 Timer

Description	Selects the default interval, in milliseconds, between transmissions of SIP messages. For details, refer to RFC 3261.
Value Range	<ul style="list-style-type: none"> • 250 • 500 • 1000 • 2000 • 4000
Default Value	500
Configuration File Reference	SIP_TIMER_T1_n (Page 195)

T2 Timer

Description	Selects the maximum interval, in seconds, between transmissions of SIP messages. For details, refer to RFC 3261.
Value Range	<ul style="list-style-type: none"> • 2 • 4 • 8 • 16 • 32
Default Value	4
Configuration File Reference	SIP_TIMER_T2_n (Page 195)

Timer B

Description	Specifies the value of SIP timer B (INVITE transaction timeout timer), in milliseconds. For details, refer to RFC 3261.
Value Range	250–64000
Default Value	32000
Configuration File Reference	SIP_TIMER_B_n (Page 207)

Timer D

Description	Specifies the value of SIP timer D (wait time for answer resending), in milliseconds. For details, refer to RFC 3261.
Value Range	0, 250–64000
Default Value	5000
Configuration File Reference	SIP_TIMER_D_n (Page 207)

Timer F

Description	Specifies the value of SIP timer F (non-INVITE transaction timeout timer), in milliseconds. For details, refer to RFC 3261.
Value Range	250–64000
Default Value	32000
Configuration File Reference	SIP_TIMER_F_n (Page 208)

Timer H

Description	Specifies the value of SIP timer H (wait time for ACK reception), in milliseconds. For details, refer to RFC 3261.
Value Range	250–64000
Default Value	32000
Configuration File Reference	SIP_TIMER_H_n (Page 208)

Timer J

Description	Specifies the value of SIP timer J (wait time for non-INVITE request resending), in milliseconds. For details, refer to RFC 3261.
Value Range	0, 250–64000
Default Value	5000
Configuration File Reference	SIP_TIMER_J_n (Page 208)

4.6.2.10 Quality of Service (QoS)

SIP Packet QoS (DSCP)

Description	Selects the DSCP (Differentiated Services Code Point) level of DiffServ applied to SIP packets.
Value Range	0–63

Default Value	0
Configuration File Reference	DSCP_SIP_n (Page 193)

4.6.2.11 SIP extensions

Supports 100rel (RFC 3262)

Description	Selects whether to add the option tag 100rel to the "Supported" header of the INVITE message. For details, refer to RFC 3262.
Value Range	<ul style="list-style-type: none"> • Yes • No <p>Note</p> <ul style="list-style-type: none"> • If you select [Yes], the Reliability of Provisional Responses function will be enabled. The option tag 100rel will be added to the "Supported" header of the INVITE message and to the "Require" header of the "1xx" provisional message. If you select [No], the option tag 100rel will not be used.
Default Value	No
Configuration File Reference	SIP_100REL_ENABLE_n (Page 198)

Supports Session Timer (RFC 4028)

Description	Specifies the length of time, in seconds, that the unit waits before terminating SIP sessions when no reply to repeated requests is received. For details, refer to RFC 4028.
Value Range	0, 60–65535 (0: Disable)
Default Value	0
Configuration File Reference	SIP_SESSION_TIME_n (Page 193)

4.6.2.12 NAT Identity

Keep Alive Interval

Description	Specifies the interval, in seconds, between transmissions of the Keep Alive packet to the unit in order to maintain the NAT binding information. <p>Note</p> <ul style="list-style-type: none"> • This setting is available only when [Transport Protocol] is set to [UDP].
Value Range	0, 10–300 (0: Disable)
Default Value	0
Configuration File Reference	PORT_PUNCH_INTVL_n (Page 201)

Supports Rport (RFC 3581)

Description	Selects whether to add the "rport" parameter to the top Via header field value of requests generated. For details, refer to RFC 3581.
Value Range	<ul style="list-style-type: none"> • Yes • No
Default Value	No
Configuration File Reference	SIP_ADD_RPORT_n (Page 201)

4.6.2.13 Security

Enable SSAF (SIP Source Address Filter)

Description	Selects whether to enable SSAF (SIP Source Address Filter) for the SIP servers (registrar server, proxy server, and presence server).
Value Range	<ul style="list-style-type: none"> • Yes • No <p>Note</p> <ul style="list-style-type: none"> • If you select [Yes], the unit receives SIP messages only from the source addresses stored in the SIP servers (registrar server, proxy server, and presence server), and not from other addresses. However, if [Outbound Proxy Server Address] in 4.6.2.3 Outbound Proxy Server is specified, the unit also receives SIP messages from the source address stored in the SIP outbound proxy server.
Default Value	No
Configuration File Reference	SIP_DETECT_SSAF_n (Page 206)

4.6.3 VoIP Settings

This screen allows you to change the VoIP settings that are common to all lines.

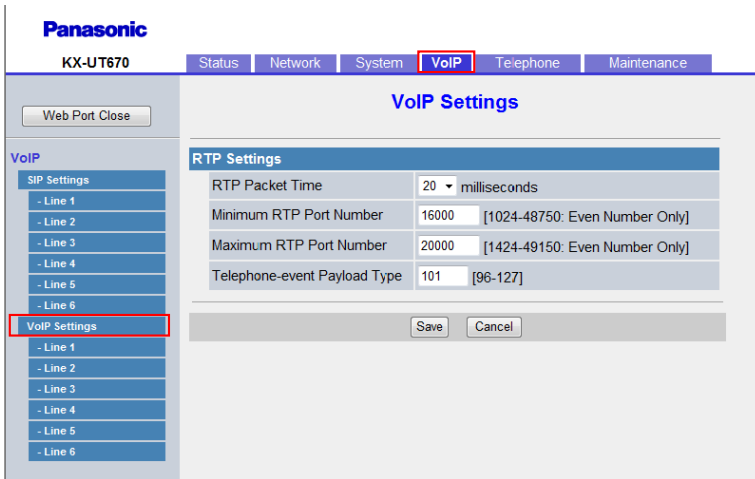

4.6.3.1 RTP Settings

RTP Packet Time

Description	Selects the interval, in milliseconds, between transmissions of RTP packets.
Value Range	<ul style="list-style-type: none"> • 20 • 30 (not available with the G.722 codec) • 40
Default Value	20
Configuration File Reference	RTP_PTIME (Page 181)

Minimum RTP Port Number

Description	<p>Specifies the lowest port number that the unit will use for RTP packets.</p> <p>Note</p> <ul style="list-style-type: none"> • If port numbers are specified in [Channel 1–25] in 4.4.5.3 External RTP Port, this setting is ignored and the corresponding external RTP port is enabled.
--------------------	--

Value Range	1024–48750 (even number only) Note <ul style="list-style-type: none"> The value for this setting must be less than or equal to "[Maximum RTP Port Number] - 400". Changing this setting may affect the number of simultaneous calls that can be made. Therefore, when setting this parameter, be aware that the maximum number of necessary ports can be calculated as shown below: No. of lines × No. of channels × 2 × 10 (No. of terminals)
Default Value	16000
Configuration File Reference	RTP_PORT_MIN (Page 180)

Maximum RTP Port Number

Description	Specifies the highest port number that the unit will use for RTP packets. Note <ul style="list-style-type: none"> If port numbers are specified in [Channel 1–25] in 4.4.5.3 External RTP Port, this setting is ignored and the corresponding external RTP port is enabled.
Value Range	1424–49150 (even number only) Note <ul style="list-style-type: none"> The value for this setting must be greater than or equal to "[Minimum RTP Port Number] + 400". Changing this setting may affect the number of simultaneous calls that can be made. Therefore, when setting this parameter, be aware that the maximum number of necessary ports can be calculated as shown below: No. of lines × No. of channels × 2 × 10 (No. of terminals)
Default Value	20000
Configuration File Reference	RTP_PORT_MAX (Page 180)

Telephone-event Payload Type

Description	Specifies the RFC 2833 payload type for DTMF tones. Note <ul style="list-style-type: none"> This setting is available only when [DTMF Type] is set to [Outband].
Value Range	96–127
Default Value	101
Configuration File Reference	TELEVENT_PAYLOAD (Page 183)

4.6.4 VoIP Settings [Line 1]–[Line 6]

This screen allows you to change the VoIP settings that are specific to each line.

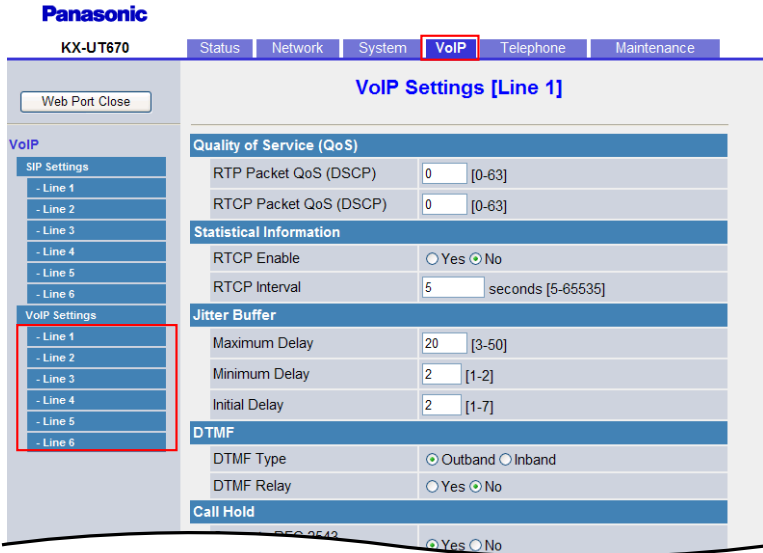

4.6.4.1 Quality of Service (QoS)

RTP Packet QoS (DSCP)

Description	Selects the DSCP level of DiffServ applied to RTP packets.
Value Range	0–63
Default Value	0
Configuration File Reference	DSCP_RTP_n (Page 178)

RTCP Packet QoS (DSCP)

Description	Selects the DSCP level of DiffServ applied to RTCP packets.
Value Range	0–63
Default Value	0
Configuration File Reference	DSCP_RTCP_n (Page 178)

4.6.4.2 Statistical Information

RTCP Enable

Description	Selects whether to enable or disable RTCP (Real-Time Transport Control Protocol). For details, refer to RFC 3550.
Value Range	<ul style="list-style-type: none"> • Yes • No
Default Value	No
Configuration File Reference	RTCP_ENABLE_n (Page 181)

RTCP Interval

Description	Specifies the interval, in seconds, between RTCP packets.
Value Range	5–65535
Default Value	5
Configuration File Reference	RTCP_INTVL_n (Page 179)

4.6.4.3 Jitter Buffer

Maximum Delay

Description	Specifies the maximum delay, in 10-millisecond units, of the jitter buffer.
Value Range	3–50 (× 10 ms) Note <ul style="list-style-type: none"> • This setting is subject to the following conditions: <ul style="list-style-type: none"> – This value must be greater than [Initial Delay] – This value must be greater than [Minimum Delay] – [Initial Delay] must be greater than or equal to [Minimum Delay]
Default Value	20 (× 10 ms)
Configuration File Reference	MAX_DELAY_n (Page 179)

Minimum Delay

Description	Specifies the minimum delay, in 10-millisecond units, of the jitter buffer.
--------------------	---

Value Range	1 or 2 (× 10 ms) Note <ul style="list-style-type: none"> • This setting is subject to the following conditions: <ul style="list-style-type: none"> – This value must be less than or equal to [Initial Delay] – This value must be less than [Maximum Delay] – [Maximum Delay] must be greater than [Initial Delay]
Default Value	2 (× 10 ms)
Configuration File Reference	MIN_DELAY_n (Page 179)

Initial Delay

Description	Specifies the initial delay, in 10-millisecond units, of the jitter buffer.
Value Range	1–7 (× 10 ms) Note <ul style="list-style-type: none"> • This setting is subject to the following conditions: <ul style="list-style-type: none"> – This value must be greater than or equal to [Minimum Delay] – This value must be less than [Maximum Delay]
Default Value	2 (× 10 ms)
Configuration File Reference	NOM_DELAY_n (Page 180)

4.6.4.4 DTMF

DTMF Type

Description	Selects the method for transmitting DTMF (Dual Tone Multi-Frequency) tones.
Value Range	<ul style="list-style-type: none"> • Outband • Inband Note <ul style="list-style-type: none"> • If you select [Outband], DTMF tones will be sent through SDP (Session Description Protocol), compliant with RFC 2833. If you select [Inband], DTMF tones will be encoded in the RTP stream.
Default Value	Outband
Configuration File Reference	OUTBANDDTMF_n (Page 182)

DTMF Relay

Description	Selects whether DTMF tones are sent in the SIP INFO message.
--------------------	--

Value Range	<ul style="list-style-type: none"> • Yes • No <p>Note</p> <ul style="list-style-type: none"> • If you select [Yes], DTMF tones will be sent in the SIP INFO message. If you select [No], the method selected in [DTMF Type] will be used.
Default Value	No
Configuration File Reference	DTMF_RELAY_n (Page 183)

4.6.4.5 Call Hold

Supports RFC 2543 (c=0.0.0.0)

Description	Selects whether to enable the RFC 2543 Call Hold feature on this line.
Value Range	<ul style="list-style-type: none"> • Yes • No <p>Note</p> <ul style="list-style-type: none"> • If you select [Yes], the "c=0.0.0.0" syntax will be set in SDP when sending a re-INVITE message to hold the call. If you select [No], the "c=x.x.x.x" syntax will be set in SDP.
Default Value	Yes
Configuration File Reference	RFC2543_HOLD_ENABLE_n (Page 183)

4.6.4.6 CODEC Preferences

G722 (Enable)

Description	Selects whether to enable the G.722 codec for voice data transmission.
Value Range	<ul style="list-style-type: none"> • Yes • No
Default Value	Yes
Configuration File Reference	CODEC_ENABLEx_n (Page 177)

G722 (Priority)

Description	Specifies the numerical order usage priority for the G.722 codec.
Value Range	1–255
Default Value	1
Configuration File Reference	CODEC_PRIORITYx_n (Page 177)

PCMA (Enable)

Description	Selects whether to enable the PCMA codec for voice data transmission.
Value Range	<ul style="list-style-type: none"> • Yes • No
Default Value	Yes
Configuration File Reference	CODEC_ENABLEx_n (Page 177)

PCMA (Priority)

Description	Specifies the numerical order usage priority for the PCMA codec.
Value Range	1–255
Default Value	1
Configuration File Reference	CODEC_PRIORITYx_n (Page 177)

G729A (Enable)

Description	Selects whether to enable the G.729A codec for voice data transmission.
Value Range	<ul style="list-style-type: none"> • Yes • No
Default Value	Yes
Configuration File Reference	CODEC_ENABLEx_n (Page 177)

G729A (Priority)

Description	Specifies the numerical order usage priority for the G.729A codec.
Value Range	1–255
Default Value	1
Configuration File Reference	CODEC_PRIORITYx_n (Page 177)

PCMU (Enable)

Description	Selects whether to enable the PCMU codec for voice data transmission.
Value Range	<ul style="list-style-type: none"> • Yes • No
Default Value	Yes
Configuration File Reference	CODEC_ENABLEx_n (Page 177)

PCMU (Priority)

Description	Specifies the numerical order usage priority for the PCMU codec.
Value Range	1–255
Default Value	1
Configuration File Reference	CODEC_PRIORITYx_n (Page 177)

4.7 Telephone

This section provides detailed descriptions about all the settings classified under the **[Telephone]** tab.

4.7.1 Call Control

This screen allows you to configure various call features that are common to all lines.

4.7.1.1 Call Control

Send SUBSCRIBE to Voice Mail Server

Description	Selects whether to send the SUBSCRIBE request to a voice mail server. Note <ul style="list-style-type: none"> Your phone system must support voice mail.
Value Range	<ul style="list-style-type: none"> Yes No

Default Value	No
Configuration File Reference	VM_SUBSCRIBE_ENABLE (Page 159)

Conference Server URI

Description	Specifies the URI for a conference server, which consists of "sip:", a user part, the "@" symbol, and a host part, for example, "sip:conference@example.com". Note <ul style="list-style-type: none"> In a SIP URI, the user part ("conference" in the example above) can contain up to 63 characters, and the host part ("example.com" in the example above) can contain up to 127 characters. Availability depends on your phone system.
Value Range	Max. 195 characters (except ", &, ', :, ;, <, >, and space)
Default Value	Not stored.
Configuration File Reference	CONFERENCE_SERVER_URI (Page 160)

Inter-digit Timeout

Description	Specifies the length of time, in seconds, within which subsequent digits of a dial number must be dialed. When this timer expires after the last key was pressed, dialing will start.
Value Range	1–15
Default Value	5
Configuration File Reference	INTDIGIT_TIM (Page 160)

Timer for Dial Plan

Description	Specifies the length of time, in seconds, that the unit waits when a "T" or "t" has been entered in the dial plan.
Value Range	1–15
Default Value	5
Configuration File Reference	MACRODIGIT_TIM (Page 160)

International Call Prefix

Description	Specifies the number to be shown in the place of the first "+" symbol when the phone number for incoming international calls contains "+".
Value Range	Max. 8 characters

Default Value	Not stored.
Configuration File Reference	INTERNATIONAL_ACCESS_CODE (Page 161)

Country Calling Code

Description	Specifies the country/area calling code to be used for comparative purposes when dialing a number from the incoming call log that contains a "+" symbol.
Value Range	Max. 8 characters
Default Value	Not stored.
Configuration File Reference	COUNTRY_CALLING_CODE (Page 161)

National Access Code

Description	When dialing a number from the incoming call log that contains a "+" symbol and the country calling code matches, the country calling code is removed and the national access code is added.
Value Range	Max. 8 characters
Default Value	Not stored.
Configuration File Reference	NATIONAL_ACCESS_CODE (Page 161)

Default Line for Outgoing

Description	Specifies the line used to make an outgoing call when no line is specified in the dialing operation.
Value Range	1–6
Default Value	1
Configuration File Reference	DEFAULT_LINE_SELECT (Page 161)

Flash/Recall Button

Description	Selects the function of the [Flash] key during a conversation.
Value Range	<ul style="list-style-type: none"> • Terminate • Flash Hook
Default Value	Terminate
Configuration File Reference	FLASH_RECALL_TERMINATE (Page 187)

Flash Hook Event

Description	Specifies the type of signal sent when sending a flash hook event.
Value Range	<ul style="list-style-type: none"> Signal flashhook
Default Value	Signal
Configuration File Reference	FLASHHOOK_CONTENT_TYPE (Page 188)

Directed Call Pickup

Description	Specifies the feature number assigned to a BLF for performing call pickup.
Value Range	Max. 4 characters
Default Value	Not stored.
Configuration File Reference	NUM_PLAN_PICKUP_DIRECT (Page 162)

4.7.1.2 Call Rejection Phone Numbers

1–30

Description	<p>Specifies the phone numbers to reject incoming calls from. A maximum of 30 phone numbers can be specified.</p> <p>Note</p> <ul style="list-style-type: none"> You can also configure this setting through the phone user interface. If these settings are changed through the phone user interface while being changed through the Web user interface, the settings made through the phone user interface will be overwritten by the settings made through the Web user interface.
Value Range	<p>Max. 32 characters</p> <p>Note</p> <ul style="list-style-type: none"> If the phone number contains characters other than 0–9, *, #, and +, the number may not be rejected correctly.
Default Value	Not stored.

4.7.2 Call Control [Line 1]–[Line 6]

This screen allows you to configure various call features that are specific to each line.

The screenshot shows the Panasonic KX-UT670 web interface. The 'Telephone' tab is selected, and the 'Call Control [Line 1]' configuration page is displayed. The 'Call Control' section is highlighted with a red box. The page includes the following fields and options:

- Display Name:** Text input field.
- Voice Mail Access Number:** Text input field.
- Enable Shared Call:** Radio buttons for Yes and No.
- Synchronize Do Not Disturb and Call Forward:** Radio buttons for Yes and No.
- Resource List URI:** Text input field.
- Dial Plan:** Text area for Dial Plan (max 500 columns).
- Call Even If Dial Plan Does Not Match:** Radio buttons for Yes and No.
- Call Features:** Radio buttons for Block Caller ID and Anonymous Call (Yes/No).

4.7.2.1 Call Control

Display Name

Description	Specifies the name to display as the caller on the other party's phone when you make a call.
Value Range	Max. 24 characters Note <ul style="list-style-type: none">You can use Unicode characters for this setting.
Default Value	Not stored.
Configuration File Reference	DISPLAY_NAME_n (Page 184)

Voice Mail Access Number

Description	Specifies the phone number used to access the voice mail server. Note <ul style="list-style-type: none">Your phone system must support voice mail.
Value Range	Max. 32 characters
Default Value	Not stored.
Configuration File Reference	VM_NUMBER_n (Page 184)

Enable Shared Call

Description	<p>Selects whether to enable the Shared Call feature of the SIP server, which is used to share one line among the units.</p> <p>Note</p> <ul style="list-style-type: none"> You cannot set both [Enable Shared Call] and [Synchronize Do Not Disturb and Call Forward] to [Yes] at the same time. Availability depends on your phone system.
Value Range	<ul style="list-style-type: none"> Yes No <p>Note</p> <ul style="list-style-type: none"> If you select [Yes], the SIP server will control the line by using a shared-call signaling method. If you select [No], the SIP server will control the line by using a standard signaling method.
Default Value	No
Configuration File Reference	SHARED_CALL_ENABLE_n (Page 186)

Synchronize Do Not Disturb and Call Forward

Description	<p>Selects whether to synchronize the Do Not Disturb and Call Forward settings, configured via the Web user interface or phone user interface, between the unit and the portal server that is provided by your phone system dealer.</p> <p>Note</p> <ul style="list-style-type: none"> Even if you select [Yes], this feature may not function properly if your phone system does not support it. Before you configure this setting, consult your phone system dealer. You cannot set both [Enable Shared Call] and [Synchronize Do Not Disturb and Call Forward] to [Yes] at the same time.
Value Range	<ul style="list-style-type: none"> Yes No
Default Value	No
Configuration File Reference	FWD_DND_SYNCHRO_ENABLE_n (Page 186)

Resource List URI

Description	Specifies the Uniform Resource Identifier string for the resource list, which consists of "sip:", a user part, the "@" symbol, and a host part, for example, "sip:user@example.com". For details, refer to RFC 4662. Note <ul style="list-style-type: none"> In a SIP URI, the user part ("user" in the example above) can contain up to 63 characters, and the host part ("example.com" in the example above) can contain up to 127 characters. When the BLF feature is assigned to a flexible button, it may be necessary to specify this parameter depending on your phone system. For details about flexible buttons, see 6.3 Registering Flexible Buttons.
Value Range	Max. 195 characters (except ", &, ', :, ;, <, >, and space)
Default Value	Not stored.
Configuration File Reference	RESOURCELIST_URI_n (Page 187)

4.7.2.2 Dial Plan

Dial Plan (max 500 columns)

Description	Specifies a dial format, such as specific phone numbers, that control which numbers can be dialed or how to handle the call when making a call. For details, see 6.6 Dial Plan .
Value Range	Max. 500 characters Note <ul style="list-style-type: none"> Entering more than 500 characters in this field causes an error and the previous value remains effective.
Default Value	Not stored.
Configuration File Reference	DIAL_PLAN_n (Page 185)

Call Even If Dial Plan Does Not Match

Description	Selects whether to make a call even if the dialed number does not match any of the dial formats specified in [Dial Plan] .
--------------------	---

Value Range	<ul style="list-style-type: none"> • Yes • No <p>Note</p> <ul style="list-style-type: none"> • If you select [Yes], calls will be made even if the dialed number does not match the dial formats specified in [Dial Plan] (i.e., dial plan filtering is disabled). If you select [No], calls will not be made if the dialed number does not match one of the dial formats specified in [Dial Plan] (i.e., dial plan filtering is enabled).
Default Value	Yes
Configuration File Reference	DIAL_PLAN_NOT_MATCH_ENABLE_n (Page 185)

4.7.2.3 Call Features

Block Caller ID

Description	<p>Selects whether to make calls without transmitting the phone number to the called party.</p> <p>Note</p> <ul style="list-style-type: none"> • Availability depends on your phone system.
Value Range	<ul style="list-style-type: none"> • Yes • No
Default Value	No

Block Anonymous Call

Description	<p>Selects whether to reject incoming calls that do not show the caller's number.</p>
Value Range	<ul style="list-style-type: none"> • Yes • No
Default Value	No

Do Not Disturb

Description	Selects whether to enable the Do Not Disturb feature for incoming calls. Note <ul style="list-style-type: none"> • If Do Not Disturb has been enabled on the server, the server rejects incoming calls and the unit does not receive any calls, even if you have selected [No] for this setting. • If you change this setting when [Synchronize Do Not Disturb and Call Forward] is set to [Yes], the change to this setting is not immediately applied on this screen. In this case, reload the screen to confirm that the change is applied.
Value Range	<ul style="list-style-type: none"> • Yes • No
Default Value	No

4.7.2.4 Call Forward

Unconditional (Enable Call Forward)

Description	Selects whether to forward all incoming calls to a specified destination. Note <ul style="list-style-type: none"> • If Do Not Disturb has been enabled on the server, the server rejects incoming calls and the unit does not receive any calls, even if you have selected [Yes] for this setting. • If you have selected [Yes] for this setting and Call Forward has been enabled on the server, but the forwarding destinations differ, incoming calls are forwarded to the destination set on the server. • If Call Forward has been enabled on the server, incoming calls are forwarded to the destination set on the server, even if you have selected [No] for this setting. • You can synchronize the Do Not Disturb and Call Forward settings from the Web user interface (→ see [Synchronize Do Not Disturb and Call Forward] in 4.7.2.1 Call Control) or through configuration file programming (→ see "FWD_DND_SYNCHRO_ENABLE_n" in 5.8.1 Call Control Settings). • If you change this setting when [Synchronize Do Not Disturb and Call Forward] is set to [Yes], the change to this setting is not immediately applied on this screen. In this case, reload the screen to confirm that the change is applied.
Value Range	<ul style="list-style-type: none"> • Yes • No
Default Value	No

Unconditional (Phone Number)

Description	<p>Specifies the phone number of the destination to forward all incoming calls to.</p> <p>Note</p> <ul style="list-style-type: none"> If you change this setting when [Synchronize Do Not Disturb and Call Forward] is set to [Yes], the change to this setting is not immediately applied on this screen. In this case, reload the screen to confirm that the change is applied.
Value Range	<p>Max. 32 characters</p> <p>Note</p> <ul style="list-style-type: none"> You cannot leave this field empty if [Unconditional (Enable Call Forward)] is set to [Yes].
Default Value	Not stored.

Busy (Enable Call Forward)

Description	<p>Selects whether to forward incoming calls to a specified destination when the line is in use.</p> <p>Note</p> <ul style="list-style-type: none"> If Do Not Disturb has been enabled on the server, the server rejects incoming calls and the unit does not receive any calls, even if you have selected [Yes] for this setting. If you have selected [Yes] for this setting and Call Forward has been enabled on the server, but the forwarding destinations differ, incoming calls are forwarded to the destination set on the server. If Call Forward has been enabled on the server, incoming calls are forwarded to the destination set on the server, even if you have selected [No] for this setting. You can synchronize the Do Not Disturb and Call Forward settings from the Web user interface (→ see [Synchronize Do Not Disturb and Call Forward] in 4.7.2.1 Call Control) or through configuration file programming (→ see "FWD_DND_SYNCHRO_ENABLE_n" in 5.8.1 Call Control Settings). If you change this setting when [Synchronize Do Not Disturb and Call Forward] is set to [Yes], the change to this setting is not immediately applied on this screen. In this case, reload the screen to confirm that the change is applied.
Value Range	<ul style="list-style-type: none"> Yes No
Default Value	No

Busy (Phone Number)

Description	<p>Specifies the phone number of the destination to forward calls to when the line is in use.</p> <p>Note</p> <ul style="list-style-type: none"> If you change this setting when [Synchronize Do Not Disturb and Call Forward] is set to [Yes], the change to this setting is not immediately applied on this screen. In this case, reload the screen to confirm that the change is applied.
Value Range	<p>Max. 32 characters</p> <p>Note</p> <ul style="list-style-type: none"> You cannot leave this field empty if [Busy (Enable Call Forward)] is set to [Yes].
Default Value	Not stored.

No Answer (Enable Call Forward)

Description	<p>Selects whether to forward incoming calls to a specified destination when a call is not answered after it has rung a specified number of times.</p> <p>Note</p> <ul style="list-style-type: none"> If Do Not Disturb has been enabled on the server, the server rejects incoming calls and the unit does not receive any calls, even if you have selected [Yes] for this setting. If you have selected [Yes] for this setting and Call Forward has been enabled on the server, but the forwarding destinations differ, incoming calls are forwarded to the destination set on the server. If Call Forward has been enabled on the server, incoming calls are forwarded to the destination set on the server, even if you have selected [No] for this setting. You can synchronize the Do Not Disturb and Call Forward settings from the Web user interface (→ see [Synchronize Do Not Disturb and Call Forward] in 4.7.2.1 Call Control) or through configuration file programming (→ see "FWD_DND_SYNCHRO_ENABLE_n" in 5.8.1 Call Control Settings). If you change this setting when [Synchronize Do Not Disturb and Call Forward] is set to [Yes], the change to this setting is not immediately applied on this screen. In this case, reload the screen to confirm that the change is applied.
Value Range	<ul style="list-style-type: none"> Yes No
Default Value	No

No Answer (Phone Number)

Description	<p>Specifies the phone number of the destination to forward calls to when a call is not answered after it has rung a specified number of times.</p> <p>Note</p> <ul style="list-style-type: none"> If you change this setting when [Synchronize Do Not Disturb and Call Forward] is set to [Yes], the change to this setting is not immediately applied on this screen. In this case, reload the screen to confirm that the change is applied.
Value Range	<p>Max. 32 characters</p> <p>Note</p> <ul style="list-style-type: none"> You cannot leave this field empty if [No Answer (Enable Call Forward)] is set to [Yes].
Default Value	Not stored.

No Answer (Ring Count)

Description	<p>Specifies the number of times that an incoming call rings until the call is forwarded.</p> <p>Note</p> <ul style="list-style-type: none"> If you change this setting when [Synchronize Do Not Disturb and Call Forward] is set to [Yes], the change to this setting is not immediately applied on this screen. In this case, reload the screen to confirm that the change is applied.
Value Range	0, 2–20 (0: No ring)
Default Value	3

4.7.3 Tone Settings

This screen allows you to configure the dual-tone frequencies and ringtone patterns of each tone.

The screenshot shows the 'Tone Settings' page for a Panasonic KX-UT670 device. The page is divided into several sections, each with input fields for 'Tone Frequencies' and 'Tone Timings'. The sections are: Dial Tone, Busy Tone, Ringing Tone, Stutter Tone, and Reorder Tone. The 'Telephone' tab is selected in the top navigation bar, and 'Tone Settings' is highlighted in the left sidebar.

Tone Type	Tone Frequencies	Tone Timings
Dial Tone	350,440	60,0
Busy Tone	480,620	60,500,440
Ringing Tone	440,480	60,2000,3940
Stutter Tone	350,440	560,100,100,100,100,100,100,100,100,100,1
Reorder Tone	480,620	60,250,190

4.7.3.1 Dial Tone Tone Frequencies

Description	Specifies the dual-tone frequencies, in hertz, of dial tones using 2 whole numbers separated by a comma.
Value Range	0, 200–2000 (0: No tone) Note <ul style="list-style-type: none"> If the value for this setting is "350,440", the unit will use a mixed signal of a 350 Hz tone and a 440 Hz tone.
Default Value	350,440
Configuration File Reference	DIAL_TONE1_FRQ (Page 166)

Tone Timings

Description	Specifies the pattern, in milliseconds, of dial tones using up to 10 whole numbers (off 1, on 1, off 2, on 2...) separated by commas.
--------------------	---

Value Range	0–16000 (0: Infinite time) Note <ul style="list-style-type: none"> The unit will not play the tone for the duration of the first value, play it for the duration of the second value, stop it for the duration of the third value, play it again for the duration of the fourth value, and so on. The whole sequence will then repeat. For example, if the value for this setting is "100,100,100,0", the unit will not play the tone for 100 ms, play it for 100 ms, stop it for 100 ms, and then play it continuously. It is recommended that you set a value of 60 milliseconds or more for the first value (off 1).
Default Value	60,0
Configuration File Reference	DIAL_TONE1_TIMING (Page 166)

4.7.3.2 Busy Tone

Tone Frequencies

Description	Specifies the dual-tone frequencies, in hertz, of busy tones using 2 whole numbers separated by a comma.
Value Range	0, 200–2000 (0: No tone)
Default Value	480,620
Configuration File Reference	BUSY_TONE_FRQ (Page 168)

Tone Timings

Description	Specifies the pattern, in milliseconds, of busy tones using up to 10 whole numbers (off 1, on 1, off 2, on 2...) separated by commas. Note <ul style="list-style-type: none"> It is recommended that you set a value of 60 milliseconds or more for the first value (off 1).
Value Range	0–16000 (0: Infinite time)
Default Value	60,500,440
Configuration File Reference	BUSY_TONE_TIMING (Page 168)

4.7.3.3 Ringing Tone

Tone Frequencies

Description	Specifies the dual-tone frequencies, in hertz, of ringback tones using 2 whole numbers separated by a comma.
--------------------	--

Value Range	0, 200–2000 (0: No tone)
Default Value	440,480
Configuration File Reference	RINGBACK_TONE_FRQ (Page 169)

Tone Timings

Description	<p>Specifies the pattern, in milliseconds, of ringback tones using up to 10 whole numbers (off 1, on 1, off 2, on 2...) separated by commas.</p> <p>Note</p> <ul style="list-style-type: none">It is recommended that you set a value of 60 milliseconds or more for the first value (off 1).
Value Range	0–16000 (0: Infinite time)
Default Value	60,2000,3940
Configuration File Reference	RINGBACK_TONE_TIMING (Page 170)

4.7.3.4 Stutter Tone

Tone Frequencies

Description	<p>Specifies the dual-tone frequencies, in hertz, of stutter dial tones to notify that a voice mail is waiting, using 2 whole numbers separated by a comma.</p>
Value Range	0, 200–2000 (0: No tone)
Default Value	350,440
Configuration File Reference	DIAL_TONE4_FRQ (Page 167)

Tone Timings

Description	<p>Specifies the pattern, in milliseconds, of stutter dial tones to notify that a voice mail is waiting, using up to 22 whole numbers (off 1, on 1, off 2, on 2...) separated by commas.</p> <p>Note</p> <ul style="list-style-type: none">It is recommended that you set a value of 560 milliseconds or more for the first value (off 1).
Value Range	0–16000 (0: Infinite time)
Default Value	560,100
Configuration File Reference	DIAL_TONE4_TIMING (Page 167)

4.7.3.5 Reorder Tone

Tone Frequencies

Description	Specifies the dual-tone frequencies, in hertz, of reorder tones using 2 whole numbers separated by a comma.
Value Range	0, 200–2000 (0: No tone)
Default Value	480,620
Configuration File Reference	REORDER_TONE_FRQ (Page 169)

Tone Timings

Description	Specifies the pattern, in milliseconds, of reorder tones using up to 10 whole numbers (off 1, on 1, off 2, on 2...) separated by commas. Note <ul style="list-style-type: none"> It is recommended that you set a value of 60 milliseconds or more for the first value (off 1).
Value Range	0–16000 (0: Infinite time)
Default Value	60,250,190
Configuration File Reference	REORDER_TONE_TIMING (Page 169)

4.7.4 Telephone Settings

This screen allows you to configure various telephone settings.

The screenshot shows the Panasonic KX-UT670 Web User Interface. At the top, there are tabs for Status, Network, System, VoIP, Telephone, and Maintenance. The 'Telephone' tab is selected. Below the tabs, there is a 'Web Port Close' button. On the left, there is a navigation menu with 'Telephone' selected, and sub-items for 'Call Control' (Line 1-6) and 'Tone Settings' (Telephone Settings). The main content area is titled 'Telephone Settings' and contains two dropdown menus: 'Number Matching Lower Digit' set to '7' and 'Number Matching Upper Digit' set to '10'. At the bottom of the form, there are 'Save' and 'Cancel' buttons.

4.7.4.1 Telephone Settings

Number Matching Lower Digit

Description	Specifies the minimum number of digits with which to match a phonebook entry with an incoming call's caller ID. To specify exact matching of entire numbers only, specify "0".
--------------------	--

Value Range	0–15
Default Value	7
Configuration File Reference	NUMBER_MATCHING_LOWER_DIGIT (Page 172)

Number Matching Upper Digit

Description	Specifies the maximum number of digits with which to match a phonebook entry with an incoming call's caller ID. To specify exact matching of entire numbers only, specify "0".
Value Range	0–15
Default Value	10
Configuration File Reference	NUMBER_MATCHING_UPPER_DIGIT (Page 172)

4.8 Maintenance

This section provides detailed descriptions about all the settings classified under the **[Maintenance]** tab.

4.8.1 Firmware Maintenance

This screen allows you to perform firmware updates automatically or manually.

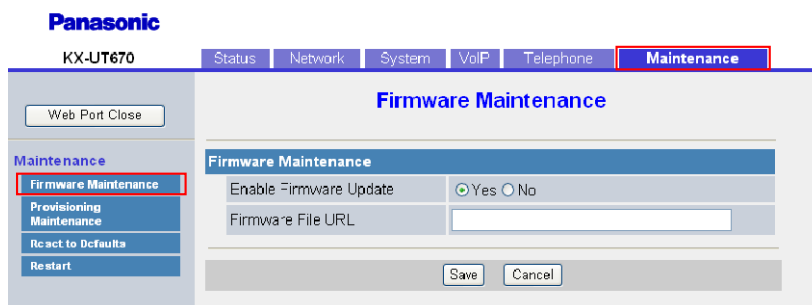

4.8.1.1 Firmware Maintenance

Enable Firmware Update

Description	Selects whether to perform firmware updates when the unit detects a newer version of firmware.
	<p>Note</p> <ul style="list-style-type: none"> • Changing this setting may require restarting the unit. • Firmware updates using the SD card can be performed regardless of this setting (→ see 7.4 Firmware Update Using the SD Card).

Value Range	<ul style="list-style-type: none"> • Yes • No
Default Value	Yes
Configuration File Reference	FIRM_UPGRADE_ENABLE (Page 143)

Firmware File URL

Description	<p>Specifies the URL where the firmware file is stored.</p> <p>Note</p> <ul style="list-style-type: none"> • This setting is available only when [Enable Firmware Update] is set to [Yes]. • Changing this setting may require restarting the unit.
Value Range	Max. 500 characters
Default Value	Not stored.
Configuration File Reference	FIRM_FILE_PATH (Page 144)

4.8.2 Provisioning Maintenance

This screen allows you to change the provisioning setup to download the configuration files from the provisioning server of your phone system.

Note

- Each unit can accept up to 3 configuration files. For details about provisioning, see **2.4.3 Provisioning**.

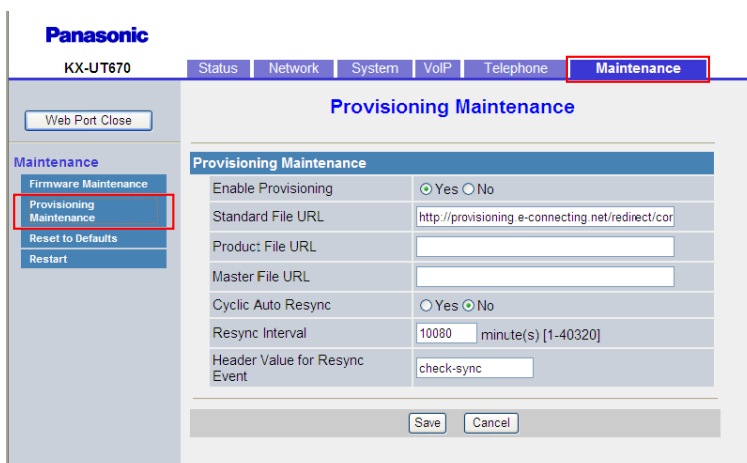

4.8.2.1 Provisioning Maintenance

Enable Provisioning

Description	Selects whether the unit is automatically configured by downloading the configuration files from the provisioning server of your phone system.
Value Range	<ul style="list-style-type: none"> • Yes • No
Default Value	Yes
Configuration File Reference	PROVISION_ENABLE (Page 145)

Standard File URL

Description	<p>Specifies the URL of the standard configuration file, which is used when every unit needs different settings.</p> <p>Note</p> <ul style="list-style-type: none"> • When you change this setting, set [Enable Provisioning] to [Yes] at the same time.
Value Range	Max. 500 characters
Default Value	http://provisioning.e-connecting.net/redirect/conf/{mac}.cfg
Configuration File Reference	CFG_STANDARD_FILE_PATH (Page 145)

Product File URL

Description	<p>Specifies the URL of the product configuration file, which is used when all units with the same model number need the same settings.</p> <p>Note</p> <ul style="list-style-type: none"> • When you change this setting, set [Enable Provisioning] to [Yes] at the same time.
Value Range	Max. 500 characters
Default Value	<p>Not stored.</p> <p>Note</p> <ul style="list-style-type: none"> • The URL specified by your phone system dealer may be preset in the unit.
Configuration File Reference	CFG_PRODUCT_FILE_PATH (Page 146)

Master File URL

Description	Specifies the URL of the master configuration file, which is used when all units need the same settings. Note <ul style="list-style-type: none"> When you change this setting, set [Enable Provisioning] to [Yes] at the same time.
Value Range	Max. 500 characters
Default Value	Not stored. Note <ul style="list-style-type: none"> The URL specified by your phone system dealer may be preset in the unit.
Configuration File Reference	CFG_MASTER_FILE_PATH (Page 147)

Cyclic Auto Resync

Description	Selects whether the unit periodically checks for updates of configuration files.
Value Range	<ul style="list-style-type: none"> Yes No
Default Value	No
Configuration File Reference	CFG_CYCLIC (Page 149)

Resync Interval

Description	Specifies the interval, in minutes, between periodic checks for updates of the configuration files.
Value Range	1–40320
Default Value	10080
Configuration File Reference	CFG_CYCLIC_INTVL (Page 150)

Header Value for Resync Event

Description	Specifies the value of the "Event" header sent from the SIP server to the unit so that the unit can access the configuration files on the provisioning server. Note <ul style="list-style-type: none"> If the SIP server directs the unit to access the configuration files on the provisioning server, the unit will be restarted.
--------------------	--

Value Range	Max. 15 characters Note • You cannot leave this field empty.
Default Value	check-sync
Configuration File Reference	CFG_RESYNC_FROM_SIP (Page 151)

4.8.3 Reset to Defaults

This screen allows you to reset the settings made through the Web user interface to their default values by clicking **[Reset Web Settings]**. After you click this button, a dialog box is displayed, asking whether you want to reset the settings. Click **OK** to reset, or **Cancel** not to. For details about the reset, see **9.2 Resetting the Settings Made through the Web User Interface (Reset Web Settings)**.

Notice

- After resetting the settings, the unit will restart even if it is being accessed through the phone user interface, or on calls.

Note

- If you have changed the default password for the Administrator account and successfully reset the settings (the message "Complete" is displayed), the next time you access the Web user interface, the authentication dialog box appears.

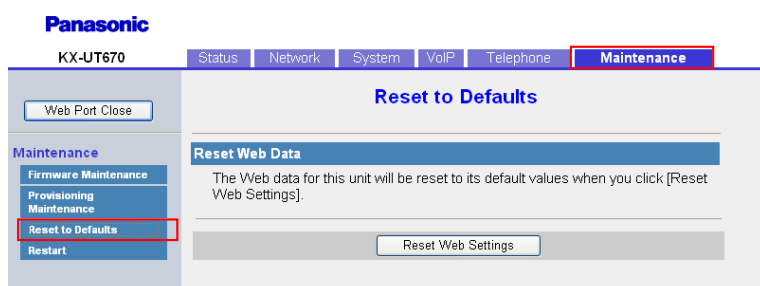

4.8.4 Restart

This screen allows you to restart the unit by clicking **[Restart]**. After you click this button, a dialog box is displayed, asking whether you want to restart the unit. Click **OK** to perform a restart, or **Cancel** not to.

Notice

- The unit will restart even if it is being accessed through the phone user interface, or on calls.

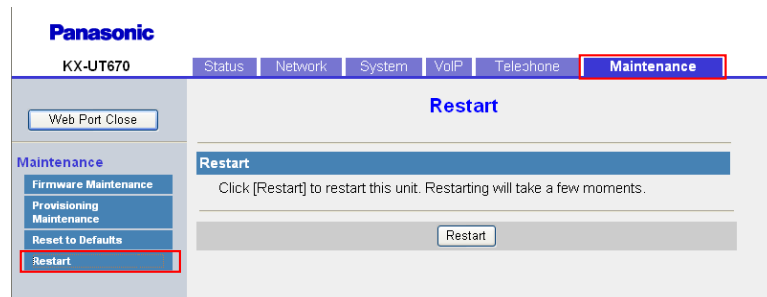

4.9 Result Messages

When you click **[Save]** after changing the settings on the current configuration screen, one of the following messages will appear in the upper-left area of the current configuration screen:

Result Message	Description	Applicable Screens
Complete	The operation has successfully completed.	All screens
Failed (Parameter Error)	The operation failed because: <ul style="list-style-type: none"> Some specified values are out of range or invalid. 	All screens
Failed (Memory Access Failure)	The operation failed because: <ul style="list-style-type: none"> Access error to the flash memory occurred while reading or writing the data. 	All screens
Failed (Transfer Failure) ^{*1}	The operation failed because: <ul style="list-style-type: none"> A network error occurred during the data transmission. 	All screens
Failed (Busy)	The operation failed because: <ul style="list-style-type: none"> The unit is in an operation that accesses the flash memory of the unit. 	All screens

*1 "Failed (Transfer Failure)" may not be displayed depending on your Web browser.

Notice

- Do not click the navigation buttons of your Web browser or open a new window to display the screen. Otherwise, an error ("403 Forbidden") will occur when you click **[Save]**.

Section 5

Configuration File Programming

This section provides information about the configuration parameters used in the configuration files.

5.1 Configuration File Parameter List

The following tables show all the parameters that can be programmed using configuration file programming. For details about each parameter, see the reference pages listed.

System Settings

Category	Parameter Name	Ref.
Login Account Settings	ADMIN_ID	Page 140
	ADMIN_PASS ^{*1}	Page 140
	USER_ID	Page 140
	USER_PASS ^{*1}	Page 140
System Time Settings	TIME_ZONE_COUNTRY	Page 141
Syslog Settings	SYSLOG_ADDR	Page 143
	SYSLOG_PORT	Page 143
Firmware Update Settings	FIRM_UPGRADE_ENABLE ^{*1}	Page 143
	FIRM_VERSION	Page 143
	FIRM_FILE_PATH ^{*1}	Page 144
Provisioning Settings	OPTION66_ENABLE	Page 144
	PROVISION_ENABLE ^{*1}	Page 145
	CFG_STANDARD_FILE_PATH ^{*1}	Page 145
	CFG_PRODUCT_FILE_PATH ^{*1}	Page 146
	CFG_MASTER_FILE_PATH ^{*1}	Page 147
	CFG_FILE_KEY1	Page 148
	CFG_FILE_KEY2	Page 149
	CFG_FILE_KEY3	Page 149
	CFG_FILE_KEY_LENGTH	Page 149
	CFG_CYCLIC ^{*1}	Page 149
	CFG_CYCLIC_INTVL ^{*1}	Page 150
	CFG_RTRY_INTVL	Page 150
	CFG_RESYNC_TIME	Page 150
	CFG_RESYNC_FROM_SIP ^{*1}	Page 151

^{*1} This setting can also be configured through the Web user interface.

Network Settings

Category	Parameter Name	Ref.
Ethernet Port Settings	LLDP_ENABLE ¹	Page 151
	LLDP_INTERVAL ¹	Page 152
	LLDP_VLAN_ID_PC ¹	Page 152
	LLDP_VLAN_PRI_PC ¹	Page 152
	VLAN_ENABLE ¹	Page 152
	VLAN_ID_IP_PHONE ¹	Page 153
	VLAN_PRI_IP_PHONE ¹	Page 153
	VLAN_ID_PC ²	Page 154
	VLAN_PRI_PC ²	Page 154
HTTP Settings	HTTPD_PORTOPEN_AUTO	Page 154
	HTTP_VER ²	Page 155
	HTTP_USER_AGENT ²	Page 155
	HTTP_SSL_VERIFY	Page 156
	CFG_ROOT_CERTIFICATE_PATH	Page 156
Time Adjust Settings	NTP_ADDR	Page 157
	TIME_SYNC_INTVL	Page 157
	TIME_QUERY_INTVL	Page 157
STUN Settings	STUN_SERV_ADDR ²	Page 157
	STUN_SERV_PORT ²	Page 158
	STUN_2NDSERV_ADDR	Page 158
	STUN_2NDSERV_PORT	Page 158
Miscellaneous Network Settings	NW_SETTING_ENABLE	Page 158
	CUSTOM_WEB_PAGE	Page 159

¹ This setting can also be configured through other programming methods (phone user interface programming or Web user interface programming).

² This setting can also be configured through the Web user interface.

Telephone Settings

Category	Parameter Name	Ref.
Call Control Settings	VM_SUBSCRIBE_ENABLE ¹	Page 159
	CONFERENCE_SERVER_URI ¹	Page 160
	FIRSTDIGIT_TIM	Page 160

Category	Parameter Name	Ref.
	INTDIGIT_TIM ¹	Page 160
	MACRODIGIT_TIM ¹	Page 160
	INTERNATIONAL_ACCESS_CODE ¹	Page 161
	COUNTRY_CALLING_CODE ¹	Page 161
	NATIONAL_ACCESS_CODE ¹	Page 161
	DEFAULT_LINE_SELECT ¹	Page 161
	DATA_LINE_MODE	Page 162
	NUM_PLAN_PICKUP_DIRECT ¹	Page 162
	TALK_PACKAGE	Page 162
	HOLD_PACKAGE	Page 162
	HOLD_RECALL_TIM	Page 163
	AUTO_ANS_RING_TIM	Page 163
	RINGING_OFF_SETTING_ENABLE	Page 163
	AUTO_CALL_HOLD	Page 163
	REDIALKEY_CALLOG_ENABLE	Page 164
	ONHOOK_TRANSFER_ENABLE	Page 164
	DISCONNECTION_MODE	Page 164
	TONE_LEN_DISCONNECT_HANDSET	Page 164
	TONE_LEN_DISCONNECT_HANDSFREE	Page 165
	KEY_PAD_TONE	Page 165
	DDI_ICD_GROUP_DISPLAY	Page 165
Tone Settings	DIAL_TONE1_FRQ ¹	Page 166
	DIAL_TONE1_GAIN	Page 166
	DIAL_TONE1_TIMING ¹	Page 166
	DIAL_TONE2_FRQ	Page 166
	DIAL_TONE2_GAIN	Page 167
	DIAL_TONE2_TIMING	Page 167
	DIAL_TONE4_FRQ ¹	Page 167
	DIAL_TONE4_GAIN	Page 167
	DIAL_TONE4_TIMING ¹	Page 167
	BUSY_TONE_FRQ ¹	Page 168
	BUSY_TONE_GAIN	Page 168
	BUSY_TONE_TIMING ¹	Page 168

Category	Parameter Name	Ref.
	REORDER_TONE_FRQ ^{*1}	Page 169
	REORDER_TONE_GAIN	Page 169
	REORDER_TONE_TIMING ^{*1}	Page 169
	RINGBACK_TONE_FRQ ^{*1}	Page 169
	RINGBACK_TONE_GAIN	Page 170
	RINGBACK_TONE_TIMING ^{*1}	Page 170
	HOLD_ALARM_FRQ	Page 170
	HOLD_ALARM_GAIN	Page 170
	HOLD_ALARM_TIMING	Page 170
	CW_TONE1_FRQ	Page 171
	CW_TONE1_GAIN	Page 171
	CW_TONE1_TIMING	Page 171
	HOLD_TONE_FRQ	Page 171
	HOLD_TONE_GAIN	Page 171
	HOLD_TONE_TIMING	Page 172
Telephone Settings	DISPLAY_NAME_REPLACE	Page 172
	NUMBER_MATCHING_LOWER_DIGIT ^{*1}	Page 172
	NUMBER_MATCHING_UPPER_DIGIT ^{*1}	Page 172
	DISPLAY_DATE_PATTERN	Page 173
	DISPLAY_TIME_PATTERN	Page 173
	DEFAULT_LANGUAGE	Page 173
	POUND_KEY_DELIMITER_ENABLE	Page 174
	WALLPAPER_URI_HOME	Page 174
	WALLPAPER_URI_PHONE	Page 174
	LOGO_URI_PHONE	Page 175
Flexible Button Settings	FLEX_BUTTON_FACILITY_ACTx	Page 175
	FLEX_BUTTON_FACILITY_ARGx	Page 175
	FLEX_BUTTON_LABELx	Page 176

^{*1} This setting can also be configured through the Web user interface.

VoIP Settings

Category	Parameter Name	Ref.
Codec Settings	CODEC_G711_REQ	Page 176
	CODEC_G729_PARAM	Page 177
	CODEC_ENABLE _{x_n} ^{*1}	Page 177
	CODEC_PRIORITY _{x_n} ^{*1}	Page 177
RTP Settings	DSCP_RTP_n ^{*1}	Page 178
	DSCP_RTCP_n ^{*1}	Page 178
	RTCP_INTVL_n ^{*1}	Page 179
	MAX_DELAY_n ^{*1}	Page 179
	MIN_DELAY_n ^{*1}	Page 179
	NOM_DELAY_n ^{*1}	Page 180
	RTP_PORT_MIN ^{*1}	Page 180
	RTP_PORT_MAX ^{*1}	Page 180
	RTP_PTIME ^{*1}	Page 181
	RTCP_ENABLE_n ^{*1}	Page 181
	RTCP_SEND_BY_SDP_n	Page 182
	RTP_CLOSE_ENABLE_n	Page 182
	Miscellaneous VoIP Settings	OUTBANDDTMF_n ^{*1}
DTMF_RELAY_n ^{*1}		Page 183
TELEVENT_PAYLOAD ^{*1}		Page 183
RFC2543_HOLD_ENABLE_n ^{*1}		Page 183
DTMF_SIGNAL_LEN		Page 184
DTMF_INTDIGIT_TIM		Page 184

^{*1} This setting can also be configured through the Web user interface.

Line Settings

Category	Parameter Name	Ref.
Call Control Settings	DISPLAY_NAME_n ^{*1}	Page 184
	VM_NUMBER_n ^{*1}	Page 184
	DIAL_PLAN_n ^{*1}	Page 185
	DIAL_PLAN_NOT_MATCH_ENABLE_n ^{*1}	Page 185
	SHARED_CALL_ENABLE_n ^{*1}	Page 186

Category	Parameter Name	Ref.
	FWD_DND_SYNCHRO_ENABLE_n ¹	Page 186
	RESOURCELIST_URI_n ¹	Page 187
	CW_ENABLE_n	Page 187
	FLASH_RECALL_TERMINATE ¹	Page 187
	FLASHHOOK_CONTENT_TYPE ¹	Page 188
	VOICE_MESSAGE_AVAILABLE	Page 188
SIP Settings	SIP_USER_AGENT ¹	Page 188
	PHONE_NUMBER_n ¹	Page 189
	SIP_URI_n ¹	Page 189
	LINE_ENABLE_n	Page 189
	PROFILE_ENABLEn	Page 190
	SIP_AUTHID_n ¹	Page 190
	SIP_PASS_n ¹	Page 190
	SIP_SRC_PORT_n ¹	Page 191
	SIP_PRXY_ADDR_n ¹	Page 191
	SIP_PRXY_PORT_n ¹	Page 191
	SIP_RGSTR_ADDR_n ¹	Page 191
	SIP_RGSTR_PORT_n ¹	Page 192
	SIP_SVCDOMAIN_n ¹	Page 192
	REG_EXPIRE_TIME_n	Page 192
	REG_INTERVAL_RATE_n	Page 193
	SIP_SESSION_TIME_n ¹	Page 193
	SIP_SESSION_METHOD_n	Page 193
	DSCP_SIP_n ¹	Page 193
	SIP_2NDPROXY_ADDR_n	Page 194
	SIP_2NDPROXY_PORT_n	Page 194
	SIP_2NDRGSTR_ADDR_n	Page 194
	SIP_2NDRGSTR_PORT_n	Page 195
	SIP_TIMER_T1_n ¹	Page 195
	SIP_TIMER_T2_n ¹	Page 195
	SIP_TIMER_T4_n	Page 196
	SIP_FOVR_NORSP_n	Page 196
	SIP_FOVR_MAX_n	Page 196

Category	Parameter Name	Ref.
	SIP_REFRESHER_n	Page 197
	SIP_DNSSRV_ENA_n ¹	Page 197
	SIP_UDP_SRV_PREFIX_n ¹	Page 197
	SIP_TCP_SRV_PREFIX_n ¹	Page 198
	SIP_100REL_ENABLE_n ¹	Page 198
	SIP_INVITE_EXPIRE_n	Page 198
	SIP_18X_RTX_INTVL_n	Page 199
	SIP_PRSNC_ADDR_n ¹	Page 199
	SIP_PRSNC_PORT_n ¹	Page 199
	SIP_2NDPRSNC_ADDR_n	Page 200
	SIP_2NDPRSNC_PORT_n	Page 200
	USE_DEL_REG_OPEN_n	Page 200
	USE_DEL_REG_CLOSE_n	Page 200
	PORT_PUNCH_INTVL_n ¹	Page 201
	SIP_ADD_RPORT_n ¹	Page 201
	SIP_REQURI_PORT_n	Page 201
	SIP_SUBS_EXPIRE_n	Page 202
	SUB_RTX_INTVL_n	Page 202
	REG_RTX_INTVL_n	Page 203
	SIP_P_PREFERRED_ID_n	Page 203
	SIP_PRIVACY_n	Page 203
	ADD_USER_PHONE_n	Page 203
	SDP_USER_ID_n	Page 204
	SUB_INTERVAL_RATE_n	Page 204
	SIP_OUTPROXY_ADDR_n ¹	Page 204
	SIP_OUTPROXY_PORT_n ¹	Page 205
	SIP_TRANSPORT_n ¹	Page 205
	SIP_ANM_DISPNAME_n	Page 205
	SIP_ANM_USERNAME_n	Page 205
	SIP_ANM_HOSTNAME_n	Page 206
	SIP_DETECT_SSAF_n ¹	Page 206
	SIP_RCV_DET_HEADER_n	Page 206
	SIP_CONTACT_ON_ACK_n	Page 207

Category	Parameter Name	Ref.
	SIP_TIMER_B_n ¹	Page 207
	SIP_TIMER_D_n ¹	Page 207
	SIP_TIMER_F_n ¹	Page 208
	SIP_TIMER_H_n ¹	Page 208
	SIP_TIMER_J_n ¹	Page 208
	ADD_TRANSPORT_UDP_n	Page 208
	ADD_EXPIRES_HEADER_n	Page 209
	SIP_HOLD_HOLDRECEIVE_n	Page 209
	SIP_ADD_DIVERSION_n	Page 209
	SIP_RESPONSE_CODE_DND	Page 210
	SIP_RESPONSE_CODE_CALL_REJECT	Page 210

¹ This setting can also be configured through the Web user interface.

5.2 General Information on the Configuration Files

5.2.1 Configuration File Specifications for Plain Text Provisioning

The specifications of plain text configuration files are as follows.
For details about XML provisioning, see **2.4.4 XML Provisioning**.

File Format

The configuration file is in plain text format (UTF-8).

File Size

The maximum size of a configuration file is 120 KB. Regardless of the number of configuration files, the total size of the configuration files must be 120 KB or less.

Lines in Plain Text Configuration Files

A configuration file consists of a sequence of lines, with the following conditions:

- Each line must end with "<CR><LF>".
- The maximum length of a line is 537 bytes including "<CR><LF>".
- The following lines are ignored:
 - Lines that exceed the limit of 537 bytes
 - Empty lines
 - Comment lines that start with "#"
- Configuration files must start with a comment line containing the following designated character sequence (44 bytes):
Panasonic SIP Phone Standard Format File
 The hexadecimal notation of this sequence is:

```
23 20 50 61 6E 61 73 6F 6E 69 63 20 53 49 50 20
50 68 6F 6E 65 20 53 74 61 6E 64 61 72 64 20 46
6F 72 6D 61 74 20 46 69 6C 65 20 23
```

- To prevent the designated character sequence being altered by chance, it is recommended that the configuration file starts with the comment line shown below:
`# Panasonic SIP Phone Standard Format File # DO NOT CHANGE THIS LINE!`
- Configuration files must end with an empty line.
- Each parameter line is written in the form of `XXX="yyy"` (XXX: parameter name, yyy: parameter value). The value must be enclosed by double quotation marks.
- A parameter line written over multiple lines is not allowed. It will cause an error on the configuration file, resulting in invalid provisioning.

Configuration Parameters

- The unit supports 6 telephone lines. For some parameters, the value for each line must be specified independently. A parameter name with the suffix "`_1`" is the parameter for line 1; "`_2`" for line 2, and so on. Examples of setting the line (phone number) for accessing a voice mail server:
`"VM_NUMBER_1"`: for line 1,
`"VM_NUMBER_2"`: for line 2, ...,
`"VM_NUMBER_6"`: for line 6
- The maximum length of a parameter name is 32 characters.
- The maximum length of a parameter value is 500 characters excluding double quotation marks.
- No space characters are allowed in the line except when the value includes a space character(s).
Example:
`DISPLAY_NAME_1="John Smith"` (valid)
`DISPLAY_NAME_1 = "John Smith"` (invalid)
- Some parameter values can be specified as "empty" to set the parameter values to empty.
Example:
`SYSLOG_ADDR=""`
- The parameters have no order.
- If the same parameter is specified in a configuration file more than once, the value specified first is applied.
- All configurable settings can be specified in the configuration file. You can ignore settings that already have the desired values. Only change parameters as necessary.

5.2.2 Configuration File Parameters

The information on each parameter that can be written in a configuration file is shown in the tables starting from **5.4 System Settings**. The information includes parameter name (as the title of the table), value format, description, permitted value range, default value of each parameter, and Web user interface reference.

Parameter Name

This is the system-predefined parameter name and cannot be changed.

Note

- Certain parameter names end with "`_n`". This signifies that these settings can be made to each line individually. The unit supports 6 telephone lines.

Value Format

Each parameter value is categorized into Integer, Boolean, or String. Some parameters require a composite form such as "Comma-separated Integer" or "Comma-separated String".

- **Integer**: a numerical value, described as a sequence of numerical characters, optionally preceded by a "-" (minus)
An empty string is not allowed.

- **Boolean:** "Y" or "N"
- **String:** sequence of alphanumerical characters
For details about available characters, see **5.2.3 Characters Available for String Values**.
- **Comma-separated Integer:** a list of integers, separated by commas
An empty string is not allowed.
- **Comma-separated String:** a list of strings, separated by commas
An empty string is not allowed.

Description

Describes the details of the parameter.

Value Range

Indicates the permitted value range of the parameter.

Default Value

Indicates the factory default value of the parameter.
Actual default values may vary depending on your phone system dealer.

Phone User Interface Reference

Provides the reference page of the corresponding parameter in phone user interface programming.

Web User Interface Reference

Provides the reference page of the corresponding parameter in Web user interface programming.

5.2.3 Characters Available for String Values

Unless noted otherwise in "Value Range", only ASCII characters can be used for parameter values. Unicode characters can also be used in some parameter values.

Available ASCII characters are shown on a white background in the following table:

	00	01	02	03	04	05	06	07	08	09	0A	0B	0C	0D	0E	0F
20	SP	!	"	#	\$	%	&	'	()	*	+	,	-	.	/
30	0	1	2	3	4	5	6	7	8	9	:	;	<	=	>	?
40	@	A	B	C	D	E	F	G	H	I	J	K	L	M	N	O
50	P	Q	R	S	T	U	V	W	X	Y	Z	[\]	^	_
60	`	a	b	c	d	e	f	g	h	i	j	k	l	m	n	o
70	p	q	r	s	t	u	v	w	x	y	z	{		}	~	

5.3 Configuration File Examples

The following examples of configuration files are provided on the Panasonic Web site (→ see **Introduction**).

- Simplified Example of the Configuration File
- Comprehensive Example of the Configuration File

5.3.1 Examples of Codec Settings

Setting the Codec Priority to (1)G.729A, (2)PCMU, (3)G.722

```
## Codec Settings
# Enable G722
CODEC_ENABLE0_1="Y"
CODEC_PRIORITY0_1="3"
# Disable PCMA
CODEC_ENABLE1_1="N"
# Enable G729A
CODEC_ENABLE3_1="Y"
CODEC_PRIORITY3_1="1"
# Enable PCMU
CODEC_ENABLE4_1="Y"
CODEC_PRIORITY4_1="2"
```

Setting Narrow-band Codecs (PCMA and G.729A)

```
## Codec Settings
# Disable G722
CODEC_ENABLE0_1="N"
# Enable PCMA
CODEC_ENABLE1_1="Y"
CODEC_PRIORITY1_1="1"
# Enable G729A
CODEC_ENABLE3_1="Y"
CODEC_PRIORITY3_1="1"
# Disable PCMU
CODEC_ENABLE4_1="N"
```

Setting the G.729A Codec Only

```
## Codec Settings
# Disable G722
CODEC_ENABLE0_1="N"
# Disable PCMA
CODEC_ENABLE1_1="N"
# Enable G729A
CODEC_ENABLE3_1="Y"
CODEC_PRIORITY3_1="1"
# Disable PCMU
CODEC_ENABLE4_1="N"
# Do not set PCMU
CODEC_G711_REQ="0"
```

5.3.2 Example with Incorrect Descriptions

The following listing shows an example of a configuration file that contains incorrect formatting:

- ❶ An improper description is entered in the first line. A configuration file must start with the designated character sequence "# Panasonic SIP Phone Standard Format File #".

- ❷ Comment lines start in the middle of the lines.
- ❸ Space characters are inserted in the middle of the setting line.
- ❹ A specified value is not in the range allowed for that setting.

Incorrect Example

```
# This is a simplified sample configuration file. —❶

#####
# Configuration Setting #
#####

CFG_STANDARD_FILE_PATH="http://config.example.com/0123456789AB.cfg"
                                # URL of this configuration file

#####
# SIP Settings #
# Suffix "_1" indicates this parameter is for "line 1". #
#####

SIP_RGSTR_ADDR_1="registrar.example.com" # IP Address or FQDN of SIP registrar server —❷
SIP_PRXY_ADDR_1="proxy.example.com"      # IP Address or FQDN of proxy server

# Enables DNS SRV lookup
SIP_DNSSRV_ENA_1="Y"

# ID, password for SIP authentication
SIP_AUTHID_1="SIP_User" —❸
SIP_PASS_1="SIP_Password"

# Some Timer Settings #
# Expiration time of SIP registration; "1 hour"
REG_EXPIRE_TIME_1="3600"
# Disables SIP Session Timer (RFC 4028)
SIP_SESSION_TIME_1="0"

# DTMF will be sent through SDP, according to RFC 2833
OUTBANDDTMF_1="Y"

#####
# Call Control Settings #
#####

# Enables subscription to the Voice Mail server
VM_SUBSCRIBE_ENABLE="Y" —❹

# Shared Call Settings
SHARED_CALL_ENABLE_1="Y"

# Disables Do Not Disturb, Call Forward synchronization
FWD_DND_SYNCHRO_ENABLE_1="N"
```

5.4 System Settings

5.4.1 Login Account Settings

ADMIN_ID

Value Format	String
Description	Specifies the account ID used to access the Web user interface with the Administrator account.
Value Range	Max. 16 characters (except ", &, ', :, <, >, and space) Note <ul style="list-style-type: none"> An empty string is not allowed.
Default Value	admin

ADMIN_PASS

Value Format	String
Description	Specifies the password to use to authenticate the Administrator account when logging in to the Web user interface.
Value Range	6–16 characters (except ", &, ', :, <, >, and space)
Default Value	adminpass
Web User Interface Reference	<ul style="list-style-type: none"> Current Password (Page 84) New Password (Page 84) Confirm New Password (Page 84)

USER_ID

Value Format	String
Description	Specifies the account ID used to access the Web user interface with the User account.
Value Range	Max. 16 characters (except ", &, ', :, <, >, and space) Note <ul style="list-style-type: none"> An empty string is not allowed.
Default Value	user

USER_PASS

Value Format	String
---------------------	--------

Description	Specifies the password to use to authenticate the User account when logging in to the Web user interface.
Value Range	6–16 characters (except ", &, ', :, <, >, and space)
Default Value	Empty string (only before a user accesses the Web user interface for the first time)
Web User Interface Reference	<ul style="list-style-type: none"> • Current Password (Page 85) • New Password (Page 85) • Confirm New Password (Page 86)

5.4.2 System Time Settings

TIME_ZONE_COUNTRY

Value Format	Integer
Description	<p>Specifies the offset of local standard time from UTC (GMT).</p> <p>Note</p> <ul style="list-style-type: none"> • If this setting is configured through phone user interface programming, changes via configuration file programming are ignored.

<p>Value Range</p>	<p>-110001–130001</p> <p>Note</p> <ul style="list-style-type: none"> Only the following values are available: -110001 (Midway Island [GMT-11:00]), -100001 (Hawaii [GMT-10:00]), -90001 (Gambier [GMT-9:00]), -90002 (Alaska [GMT-9:00]), -80001 (Tijuana [GMT-8:00]), -80002 (Pacific Time [GMT-8:00]), -70001 (Chihuahua [GMT-7:00]), -70002 (Mountain Time [GMT-7:00]), -70003 (Arizona [GMT-7:00]), -60001 (Saskatchewan [GMT-6:00]), -60002 (Mexico City [GMT-6:00]), -60003 (Central Time [GMT-6:00]), -60004 (Central America [GMT-6:00]), -50001 (Eastern Time [GMT-5:00]), -50002 (Bogota [GMT-5:00]), -45001 (Venezuela [GMT-4:30]), -40001 (Santiago [GMT-4:00]), -40002 (Manaus [GMT-4:00]), -40003 (Atlantic Time [GMT-4:00]), -35001 (Newfoundland [GMT-3:30]), -30001 (Montevideo [GMT-3:00]), -30002 (Greenland [GMT-3:00]), -30003 (Buenos Aires [GMT-3:00]), -30004 (Brasilia [GMT-3:00]), -20001 (Mid-Atlantic [GMT-2:00]), -10001 (Azores [GMT-1:00]), -10002 (Cape Verde Islands [GMT-1:00]), 1 (Casablanca [GMT+0:00]), 2 (London, Dublin [GMT+0:00]), 10001 (Amsterdam, Berlin [GMT+1:00]), 10002 (Belgrade [GMT+1:00]), 10003 (Brussels [GMT+1:00]), 10004 (Sarajevo [GMT+1:00]), 10005 (W. Africa Time [GMT+1:00]), 10006 (Windhoek [GMT+1:00]), 20001 (Amman, Jordan [GMT+2:00]), 20002 (Athens, Istanbul [GMT+2:00]), 20003 (Beirut, Lebanon [GMT+2:00]), 20004 (Cairo [GMT+2:00]), 20005 (Helsinki [GMT+2:00]), 20006 (Jerusalem [GMT+2:00]), 20007 (Harare [GMT+2:00]), 20008 (Minsk [GMT+2:00]), 20009 (Kaliningrad [GMT+3:00]), 30001 (Baghdad [GMT+3:00]), 30002 (Moscow [GMT+4:00]), 30003 (Kuwait [GMT+3:00]), 30004 (Nairobi [GMT+3:00]), 35001 (Tehran [GMT+3:30]), 40001 (Baku [GMT+4:00]), 40002 (Tbilisi [GMT+4:00]), 40003 (Yerevan [GMT+4:00]), 40004 (Dubai [GMT+4:00]), 45001 (Kabul [GMT+4:30]), 50001 (Islamabad, Karachi [GMT+5:00]), 50002 (Ural'sk [GMT+5:00]), 50003 (Yekaterinburg [GMT+6:00]), 55001 (Kolkata [GMT+5:30]), 55002 (Sri Lanka [GMT+5:30]), 57501 (Kathmandu [GMT+5:45]), 60001 (Astana [GMT+6:00]), 60002 (Novosivirsk [GMT+7:00]), 65001 (Yangon [GMT+6:30]), 70001 (Krasnoyarsk [GMT+8:00]), 70002 (Bangkok [GMT+7:00]), 80001 (Kuala Lumpur [GMT+8:00]), 80002 (Beijing [GMT+8:00]), 80003 (Irkutsk [GMT+9:00]), 80004 (Hong Kong [GMT+8:00]), 80005 (Perth [GMT+8:00]), 80006 (Taipei [GMT+8:00]), 90001 (Tokyo, Osaka [GMT+9:00]), 90002 (Seoul [GMT+9:00]), 90003 (Yakutsk [GMT+10:00]), 95001 (Darwin [GMT+9:30]), 95002 (Adelaide [GMT+9:30]), 100001 (Brisbane [GMT+10:00]), 100002 (Vladivostok [GMT+11:00]), 100003 (Guam [GMT+10:00]), 100004 (Sydney, Canberra [GMT+10:00]), 100005 (Hobart [GMT+10:00]), 110001 (Magadan [GMT+12:00]), 120001 (Marshall Islands [GMT+12:00]), 120002 (Fiji [GMT+12:00]), 120003 (Auckland [GMT+12:00]), 130001 (Tonga [GMT+13:00])
---------------------------	--

Default Value	1 (Casablanca [GMT+0:00])
---------------	---------------------------

5.4.3 Syslog Settings

SYSLOG_ADDR

Value Format	String
Description	Specifies the IP address or FQDN of the syslog server.
Value Range	Max. 127 characters (IP address in dotted-decimal notation or FQDN)
Default Value	Empty string

SYSLOG_PORT

Value Format	Integer
Description	Specifies the port number of the syslog server.
Value Range	1–65535
Default Value	514

5.4.4 Firmware Update Settings

FIRM_UPGRADE_ENABLE

Value Format	Boolean
Description	Specifies whether to perform firmware updates when the unit detects a newer version of firmware. Note <ul style="list-style-type: none"> • Changing this setting may require restarting the unit. • Firmware updates using the SD card can be performed regardless of this setting (→ see 7.4 Firmware Update Using the SD Card).
Value Range	<ul style="list-style-type: none"> • Y (Enable firmware updates) • N (Disable firmware updates)
Default Value	Y
Web User Interface Reference	Enable Firmware Update (Page 121)

FIRM_VERSION

Value Format	String
--------------	--------

Description	Specifies the firmware version of the unit. Note <ul style="list-style-type: none"> Changing this setting may require restarting the unit.
Value Range	00.000–15.999
Default Value	Empty string

FIRM_FILE_PATH

Value Format	String
Description	Specifies the URL where the firmware file is stored. Note <ul style="list-style-type: none"> This setting is available only when "FIRM_UPGRADE_ENABLE" is set to "Y". Changing this setting may require restarting the unit.
Value Range	Max. 500 characters Note <ul style="list-style-type: none"> The format must be RFC 1738 compliant, as follows: <ul style="list-style-type: none"> "<scheme>://<user>:<password>@<host>:<port>/<url-path>". "<user>" must be less than 128 characters. "<password>" must be less than 128 characters. "<user>:<password>@" may be empty. The total of "<scheme>://" and "<host>:<port>/<url-path>" must be less than 245 characters. ":<port>" can be omitted if you do not need to specify the port number. If "{mac}" is included in this URL, it will be replaced with the unit's MAC address in lower-case. If "{MAC}" is included in this URL, it will be replaced with the unit's MAC address in upper-case. If "{MODEL}" is included in this URL, it will be replaced with the unit's model name. If "{fwver}" is included in this URL, it will be replaced with "FIRM_VERSION" depending on the system. Note that this rule differs from other parameters such as "SIP_USER_AGENT".
Default Value	Empty string
Web User Interface Reference	Firmware File URL (Page 122)

5.4.5 Provisioning Settings

OPTION66_ENABLE

Value Format	Boolean
---------------------	---------

Description	Specifies whether to enable the unit to look for option 66 to receive the TFTP server address or FQDN from the DHCP server. Note <ul style="list-style-type: none"> The unit will try to download configuration files through the TFTP server, the IP address or FQDN of which is specified in the option number 66 field.
Value Range	<ul style="list-style-type: none"> Y (Enable option 66) N (Disable option 66)
Default Value	Y

PROVISION_ENABLE

Value Format	Boolean
Description	Specifies whether the unit is automatically configured by downloading the configuration files from the provisioning server of your phone system.
Value Range	<ul style="list-style-type: none"> Y (Enable configuration file download) N (Disable configuration file download)
Default Value	Y
Web User Interface Reference	Enable Provisioning (Page 123)

CFG_STANDARD_FILE_PATH

Value Format	String
Description	Specifies the URL of the standard configuration file, which is used when every unit needs different settings. Note <ul style="list-style-type: none"> When you change this setting, set "PROVISION_ENABLE" to "Y" at the same time.

Value Range	<p>Max. 500 characters</p> <p>Note</p> <ul style="list-style-type: none"> The format must be RFC 1738 compliant, as follows: "<code><scheme>://<user>:<password>@<host>:<port>/<url-path></code>" <ul style="list-style-type: none"> "<code><user></code>" must be less than 128 characters. "<code><password></code>" must be less than 128 characters. "<code><user>:<password>@</code>" may be empty. The total of "<code><scheme>://</code>" and "<code><host>:<port>/<url-path></code>" must be less than 245 characters. "<code>:<port></code>" can be omitted if you do not need to specify the port number. If "<code>{mac}</code>" is included in this URL, it will be replaced with the unit's MAC address in lower-case. If "<code>{MAC}</code>" is included in this URL, it will be replaced with the unit's MAC address in upper-case. If "<code>{MODEL}</code>" is included in this URL, it will be replaced with the unit's model name. If "<code>{fwver}</code>" is included in this URL, it will be replaced with the unit's firmware version. If this URL ends with "/" (slash), "Config<code>{mac}</code>.cfg" is automatically added at the end of the URL. For example, <code>CFG_STANDARD_FILE_PATH="http://host/dir/"</code> becomes <code>CFG_STANDARD_FILE_PATH="http://host/dir/Config{mac}.cfg"</code>.
Default Value	http://provisioning.e-connecting.net/redirect/conf/{mac}.cfg
Web User Interface Reference	Standard File URL (Page 123)

CFG_PRODUCT_FILE_PATH

Value Format	String
Description	<p>Specifies the URL of the product configuration file, which is used when all units with the same model number need the same settings.</p> <p>Note</p> <ul style="list-style-type: none"> When you change this setting, set "<code>PROVISION_ENABLE</code>" to "<code>Y</code>" at the same time.

Value Range	<p>Max. 500 characters</p> <p>Note</p> <ul style="list-style-type: none"> The format must be RFC 1738 compliant, as follows: <ul style="list-style-type: none"> "<scheme>://<user>:<password>@<host>:<port>/<url-path>" <ul style="list-style-type: none"> "<user>" must be less than 128 characters. "<password>" must be less than 128 characters. "<user>:<password>@" may be empty. The total of "<scheme>://" and "<host>:<port>/<url-path>" must be less than 245 characters. ":<port>" can be omitted if you do not need to specify the port number. If "{mac}" is included in this URL, it will be replaced with the unit's MAC address in lower-case. If "{MAC}" is included in this URL, it will be replaced with the unit's MAC address in upper-case. If "{MODEL}" is included in this URL, it will be replaced with the unit's model name. If "{fwver}" is included in this URL, it will be replaced with the unit's firmware version. If this URL ends with "/" (slash), "{MODEL}.cfg" is automatically added at the end of the URL. <p>For example, <code>CFG_PRODUCT_FILE_PATH="http://host/dir/"</code> becomes <code>CFG_PRODUCT_FILE_PATH="http://host/dir/{MODEL}.cfg"</code>.</p>
Default Value	<p>Empty string</p> <p>Note</p> <ul style="list-style-type: none"> The URL specified by your phone system dealer may be preset in the unit.
Web User Interface Reference	Product File URL (Page 123)

CFG_MASTER_FILE_PATH

Value Format	String
Description	<p>Specifies the URL of the master configuration file, which is used when all units need the same settings.</p> <p>Note</p> <ul style="list-style-type: none"> When you change this setting, set "<code>PROVISION_ENABLE</code>" to "<code>y</code>" at the same time.

Value Range	<p>Max. 500 characters</p> <p>Note</p> <ul style="list-style-type: none"> The format must be RFC 1738 compliant, as follows: "<code><scheme>://<user>:<password>@<host>:<port>/<url-path></code>" <ul style="list-style-type: none"> "<code><user></code>" must be less than 128 characters. "<code><password></code>" must be less than 128 characters. "<code><user>:<password>@</code>" may be empty. The total of "<code><scheme>://</code>" and "<code><host>:<port>/<url-path></code>" must be less than 245 characters. "<code>:<port></code>" can be omitted if you do not need to specify the port number. If "{mac}" is included in this URL, it will be replaced with the unit's MAC address in lower-case. If "{MAC}" is included in this URL, it will be replaced with the unit's MAC address in upper-case. If "{MODEL}" is included in this URL, it will be replaced with the unit's model name. If "{fwver}" is included in this URL, it will be replaced with the unit's firmware version. If this URL ends with "/" (slash), "sip.cfg" is automatically added at the end of the URL. For example, <code>CFG_MASTER_FILE_PATH="http://host/dir/"</code> becomes <code>CFG_MASTER_FILE_PATH="http://host/dir/sip.cfg"</code>.
Default Value	<p>Empty string</p> <p>Note</p> <ul style="list-style-type: none"> The URL specified by your phone system dealer may be preset in the unit.
Web User Interface Reference	Master File URL (Page 124)

CFG_FILE_KEY1

Value Format	String
Description	<p>Specifies the encryption key (password) used to decrypt configuration files.</p> <p>Note</p> <ul style="list-style-type: none"> If the extension of the configuration file is ".e1c", the configuration file will be decrypted using this key.
Value Range	<p>32-byte characters</p> <p>Note</p> <ul style="list-style-type: none"> If an empty string is set for this parameter, decryption with this value is disabled.
Default Value	A unique value is preset to each unit.

CFG_FILE_KEY2

Value Format	String
Description	Specifies the encryption key (password) used to decrypt configuration files. Note <ul style="list-style-type: none"> If the extension of the configuration file is ".e2c", the configuration file will be decrypted using this key.
Value Range	32-byte characters Note <ul style="list-style-type: none"> If an empty string is set for this parameter, decryption with this value is disabled.
Default Value	Empty string

CFG_FILE_KEY3

Value Format	String
Description	Specifies the encryption key (password) used to decrypt configuration files. Note <ul style="list-style-type: none"> If the extension of the configuration file is ".e3c", the configuration file will be decrypted using this key.
Value Range	32-byte characters Note <ul style="list-style-type: none"> If an empty string is set for this parameter, decryption with this value is disabled.
Default Value	Empty string

CFG_FILE_KEY_LENGTH

Value Format	Integer
Description	Specifies the key lengths in bits used to decrypt configuration files.
Value Range	<ul style="list-style-type: none"> 128 192 256
Default Value	128

CFG_CYCLIC

Value Format	Boolean
---------------------	---------

Description	Specifies whether the unit periodically checks for updates of configuration files.
Value Range	<ul style="list-style-type: none"> • Y (Enable periodic synchronization of configuration files) • N (Disable periodic synchronization of configuration files)
Default Value	N
Web User Interface Reference	Cyclic Auto Resync (Page 124)

CFG_CYCLIC_INTVL

Value Format	Integer
Description	<p>Specifies the interval, in minutes, between periodic checks for updates of the configuration files.</p> <p>Note</p> <ul style="list-style-type: none"> • This setting is available only when "CFG_CYCLIC" is set to "Y".
Value Range	1–40320
Default Value	10080
Web User Interface Reference	Resync Interval (Page 124)

CFG_RTRY_INTVL

Value Format	Integer
Description	<p>Specifies the period of time, in minutes, that the unit will retry checking for an update of the configuration files after a configuration file access error has occurred.</p> <p>Note</p> <ul style="list-style-type: none"> • This setting is available only when "CFG_CYCLIC" is set to "Y".
Value Range	1–1440
Default Value	30

CFG_RESYNC_TIME

Value Format	String
Description	Specifies the time (hour:minute) that the unit checks for updates of configuration files.

Value Range	00:00–23:59 Note <ul style="list-style-type: none"> If the value for this setting is any valid value other than an empty string, the unit downloads the configuration files at the fixed time, and the settings specified in "CFG_CYCLIC", "CFG_CYCLIC_INTVL", and "CFG_RTRY_INTVL" are disabled. If the value for this setting is an empty string, downloading the configuration files at the fixed time are disabled.
Default Value	Empty string

CFG_RESYNC_FROM_SIP

Value Format	String
Description	Specifies the value of the "Event" header sent from the SIP server to the unit so that the unit can access the configuration files on the provisioning server. Note <ul style="list-style-type: none"> If the SIP server directs the unit to access the configuration files on the provisioning server, the unit will be restarted.
Value Range	Max. 15 characters Note <ul style="list-style-type: none"> An empty string is not allowed.
Default Value	check-sync
Web User Interface Reference	Header Value for Resync Event (Page 124)

5.5 Network Settings

5.5.1 Ethernet Port Settings

LLDP_ENABLE

Value Format	Boolean
Description	Selects whether to enable or disable sending and receiving LLDP frames.
Value Range	<ul style="list-style-type: none"> Y (Enable) N (Disable)
Default Value	Y
Phone User Interface Reference	Ethernet Settings (Page 17)

Web User Interface Reference	LLDP (Page 74)
-------------------------------------	----------------

LLDP_INTERVAL

Value Format	Integer
Description	Specifies the interval, in seconds, between sending each LLDP frame.
Value Range	1–3600
Default Value	30
Phone User Interface Reference	Ethernet Settings (Page 17)
Web User Interface Reference	LLDP-MED Interval timer (Page 74)

LLDP_VLAN_ID_PC

Value Format	Integer
Description	Specifies the VLAN ID for the PC port when LLDP is on.
Value Range	0–4094
Default Value	0
Web User Interface Reference	PC (VLAN ID) (Page 75)

LLDP_VLAN_PRI_PC

Value Format	Integer
Description	Specifies the VLAN Priority for the PC port when LLDP is on.
Value Range	0–7
Default Value	0
Web User Interface Reference	PC (Priority) (Page 75)

VLAN_ENABLE

Value Format	Boolean
---------------------	---------

Description	Specifies whether to use the VLAN feature to perform VoIP communication securely. Note <ul style="list-style-type: none"> This setting is available only when "NW_SETTING_ENABLE" is set to "N". If this setting is configured through phone user interface programming, changes via configuration file programming are ignored.
Value Range	<ul style="list-style-type: none"> Y (Enable) N (Disable)
Default Value	N
Phone User Interface Reference	Ethernet Settings (Page 17)
Web User Interface Reference	Enable VLAN (Page 75)

VLAN_ID_IP_PHONE

Value Format	Integer
Description	Specifies the VLAN ID for this unit. Note <ul style="list-style-type: none"> This setting is available only when "NW_SETTING_ENABLE" is set to "N". If this setting is configured through phone user interface programming, changes via configuration file programming are ignored.
Value Range	1–4094
Default Value	2
Phone User Interface Reference	Ethernet Settings (Page 17)
Web User Interface Reference	IP Phone (VLAN ID) (Page 75)

VLAN_PRI_IP_PHONE

Value Format	Integer
Description	Specifies the priority number for the unit. Note <ul style="list-style-type: none"> This setting is available only when "NW_SETTING_ENABLE" is set to "N". If this setting is configured through phone user interface programming, changes via configuration file programming are ignored.

Value Range	0–7
Default Value	7
Phone User Interface Reference	Ethernet Settings (Page 17)
Web User Interface Reference	IP Phone (Priority) (Page 76)

VLAN_ID_PC

Value Format	Integer
Description	Specifies the VLAN ID for the PC. Note <ul style="list-style-type: none"> This setting is available only when "NW_SETTING_ENABLE" is set to "N". If this setting is configured through phone user interface programming, changes via configuration file programming are ignored.
Value Range	1–4094
Default Value	1
Web User Interface Reference	PC (VLAN ID) (Page 76)

VLAN_PRI_PC

Value Format	Integer
Description	Specifies the priority number for the PC. Note <ul style="list-style-type: none"> This setting is available only when "NW_SETTING_ENABLE" is set to "N". If this setting is configured through phone user interface programming, changes via configuration file programming are ignored.
Value Range	0–7
Default Value	0
Web User Interface Reference	PC (Priority) (Page 76)

5.5.2 HTTP Settings

HTTPD_PORTOPEN_AUTO

Value Format	Boolean
---------------------	---------

Description	Specifies whether the unit's Web port is always open.
Value Range	<ul style="list-style-type: none"> • Y (Web port is always open) • N (Web port is closed [can be opened temporarily through phone user interface programming]) <p>Notice</p> <ul style="list-style-type: none"> • If you want to set to "Y", please fully recognize the possibility of unauthorized access to the unit through the Web user interface and change this setting at your own risk. In addition, please take full security measures for connecting to an external network and control all passwords for logging in to the Web user interface.
Default Value	N

HTTP_VER

Value Format	Integer
Description	Specifies which version of the HTTP protocol to use for HTTP communication.
Value Range	<ul style="list-style-type: none"> • 1 (Use HTTP 1.0) • 0 (Use HTTP 1.1) <p>Note</p> <ul style="list-style-type: none"> • For this unit, it is strongly recommended that you specify "1" for this setting. However, if the HTTP server does not function well with HTTP 1.0, try changing the setting "0".
Default Value	1
Web User Interface Reference	HTTP Version (Page 77)

HTTP_USER_AGENT

Value Format	String
Description	Specifies the text string to send as the user agent in the header of HTTP requests.
Value Range	<p>Max. 40 characters</p> <p>Note</p> <ul style="list-style-type: none"> • An empty string is not allowed. • If "{mac}" is included in this parameter, it will be replaced with the unit's MAC address in lower-case. • If "{MAC}" is included in this parameter, it will be replaced with the unit's MAC address in upper-case. • If "{MODEL}" is included in this parameter, it will be replaced with the unit's model name. • If "{fwver}" is included in this parameter, it will be replaced with the firmware version of the unit.

Default Value	Panasonic_{MODEL}/{fwver} ({mac})
Web User Interface Reference	HTTP User Agent (Page 77)

HTTP_SSL_VERIFY

Value Format	Integer
Description	Specifies whether to enable the verification of the root certificate.
Value Range	<ul style="list-style-type: none"> • 0 (No verification of root certificate) • 1 (Simple verification of root certificate) • 2 (Precise verification of root certificate) <p>Note</p> <ul style="list-style-type: none"> • If set to "0", the verification of the root certificate is disabled. • If set to "1", the verification of the root certificate is enabled. In this case, the validity of the certificate's date, certificate's chain, and the confirmation of the root certificate will be verified. • If set to "2", precise certificate verification is enabled. In this case, the validity of the server name will be verified in addition to the items verified when "1" is set. • If the unit has not obtained the current time, verification will not be performed irrelevant of this setting. In order to perform verification it is necessary to first set up the NTP server.
Default Value	0

CFG_ROOT_CERTIFICATE_PATH

Value Format	String
Description	<p>Specifies the URI of the root certificate.</p> <p>Note</p> <ul style="list-style-type: none"> • Changing this setting may require restarting the unit.
Value Range	<p>Max. 500 characters</p> <p>Note</p> <ul style="list-style-type: none"> • The format must be RFC 1738 compliant, as follows: <ul style="list-style-type: none"> – "<scheme>://<user>:<password>@<host>:<port>/<url-path>" – "<user>" must be less than 128 characters. – "<password>" must be less than 128 characters. – "<user>:<password>@" may be empty. – The total of "<scheme>://" and "<host>:<port>/<url-path>" must be less than 245 characters. – ":<port>" can be omitted if you do not need to specify the port number.
Default Value	Empty string

5.5.3 Time Adjust Settings

NTP_ADDR

Value Format	String
Description	Specifies the IP address or FQDN of the NTP server. Note <ul style="list-style-type: none"> If NTP settings are performed via the unit, this setting is disabled.
Value Range	Max. 127 characters (IP address in dotted-decimal notation or FQDN)
Default Value	Empty string

TIME_SYNC_INTVL

Value Format	Integer
Description	Specifies the interval, in seconds, to resynchronize after having detected no reply from the NTP server. Note <ul style="list-style-type: none"> If NTP settings are performed via the unit, this setting is disabled.
Value Range	10–86400
Default Value	60

TIME_QUERY_INTVL

Value Format	Integer
Description	Specifies the interval, in seconds, between synchronizations with the NTP server. Note <ul style="list-style-type: none"> If NTP settings are performed via the unit, this setting is disabled.
Value Range	10–86400
Default Value	43200

5.5.4 STUN Settings

STUN_SERV_ADDR

Value Format	String
Description	Specifies the IP address or FQDN of the STUN server.

Value Range	Max. 127 characters (IP address in dotted-decimal notation or FQDN)
Default Value	Empty string
Web User Interface Reference	STUN Server Address (Page 80)

STUN_SERV_PORT

Value Format	Integer
Description	Specifies the port number of the STUN server.
Value Range	1–65535
Default Value	3478
Web User Interface Reference	STUN Server Port (Page 80)

STUN_2NDSERV_ADDR

Value Format	String
Description	Specifies the IP address of the secondary STUN server. Note <ul style="list-style-type: none"> This setting is available only when "STUN_SERV_ADDR" is specified in IP address notation.
Value Range	IP address in dotted-decimal notation
Default Value	Empty string

STUN_2NDSERV_PORT

Value Format	Integer
Description	Specifies the port number of the secondary STUN server.
Value Range	1–65535
Default Value	3478

5.5.5 Miscellaneous Network Settings

NW_SETTING_ENABLE

Value Format	Boolean
---------------------	---------

Description	Specifies whether to enable network and NTP server settings from the unit. Note <ul style="list-style-type: none"> If you change this setting to "N" when network or NTP server settings have been made through Web user interface programming (→ see 4.4.1 Basic Network Settings), clear these settings once by performing Reset Web Settings from the Web user interface, and then change this setting to "N".
Value Range	<ul style="list-style-type: none"> Y (Enable network and NTP server settings) N (Disable network and NTP server settings)
Default Value	Y

CUSTOM_WEB_PAGE

Value Format	Integer
Description	Specifies whether to enable the settings in 4.4.1 Basic Network Settings from the Web user interface when logged in with the User account.
Value Range	0–1 <ul style="list-style-type: none"> 0: Enable "Basic Network Settings" 1: Disable "Basic Network Settings"
Default Value	0

5.6 Telephone Settings

5.6.1 Call Control Settings

VM_SUBSCRIBE_ENABLE

Value Format	Boolean
Description	Specifies whether to send the SUBSCRIBE request to a voice mail server. Note <ul style="list-style-type: none"> Your phone system must support voice mail.
Value Range	<ul style="list-style-type: none"> Y (Send the SUBSCRIBE request) N (Do not send the SUBSCRIBE request)
Default Value	N
Web User Interface Reference	Send SUBSCRIBE to Voice Mail Server (Page 105)

CONFERENCE_SERVER_URI

Value Format	String
Description	<p>Specifies the URI for a conference server, which consists of "sip:", a user part, the "@" symbol, and a host part, for example, "sip:conference@example.com".</p> <p>Note</p> <ul style="list-style-type: none"> In a SIP URI, the user part ("conference" in the example above) can contain up to 63 characters, and the host part ("example.com" in the example above) can contain up to 127 characters. Availability depends on your phone system.
Value Range	Max. 195 characters (except ", &, ', :, ;, <, >, and space)
Default Value	Empty string
Web User Interface Reference	Conference Server URI (Page 106)

FIRSTDIGIT_TIM

Value Format	Integer
Description	Specifies the length of time, in seconds, within which the first digits of a dial number must be dialed. When this timer expires, the unit will play a busy tone.
Value Range	1–600
Default Value	30

INTDIGIT_TIM

Value Format	Integer
Description	Specifies the length of time, in seconds, within which subsequent digits of a dial number must be dialed. When this timer expires after the last key was pressed, dialing will start.
Value Range	1–15
Default Value	5
Web User Interface Reference	Inter-digit Timeout (Page 106)

MACRODIGIT_TIM

Value Format	Integer
Description	Specifies the length of time, in seconds, that the unit waits when a "T" or "t" has been entered in the dial plan.
Value Range	1–15

Default Value	5
Web User Interface Reference	Timer for Dial Plan (Page 106)

INTERNATIONAL_ACCESS_CODE

Value Format	String
Description	Specifies the number to be shown in the place of the first "+" symbol when the phone number for incoming international calls contains "+".
Value Range	Max. 8 characters (consisting of 0–9, *, and #) Note <ul style="list-style-type: none"> No other characters are allowed.
Default Value	Empty string ("+" is deleted)
Web User Interface Reference	International Call Prefix (Page 106)

COUNTRY_CALLING_CODE

Value Format	String
Description	Specifies the country/area calling code to be used for comparative purposes when dialing a number from the incoming call log that contains a "+" symbol.
Value Range	Max. 8 characters (consisting of 0–9)
Default Value	Empty string
Web User Interface Reference	Country Calling Code (Page 107)

NATIONAL_ACCESS_CODE

Value Format	String
Description	When dialing a number from the incoming call log that contains a "+" symbol and the country calling code matches, the country calling code is removed and the national access code is added.
Value Range	Max. 8 characters (consisting of 0–9, *, and #)
Default Value	Empty string
Web User Interface Reference	National Access Code (Page 107)

DEFAULT_LINE_SELECT

Value Format	Integer
Description	Specifies the line used to make an outgoing call when no line is specified in the dialing operation.

Value Range	1–6
Default Value	1
Web User Interface Reference	Default Line for Outgoing (Page 107)

DATA_LINE_MODE

Value Format	Boolean
Description	Specifies whether to enable sending and receiving using data line mode.
Value Range	<ul style="list-style-type: none"> Y (Enable Data Line Mode) N (Disable Data Line Mode)
Default Value	N

NUM_PLAN_PICKUP_DIRECT

Value Format	String
Description	Specifies the feature number assigned to a BLF for performing call pickup.
Value Range	Max. 4 characters (consisting of 0–9, *, and #)
Default Value	Empty string
Web User Interface Reference	Directed Call Pickup (Page 108)

TALK_PACKAGE

Value Format	Boolean
Description	<p>Specifies whether to enable the Click to Answer/Retrieve functions.</p> <p>Note</p> <ul style="list-style-type: none"> When this parameter is set to "Y", "talk" is added to the Allow-Events header.
Value Range	<ul style="list-style-type: none"> Y (Enable Talk Package) N (Disable Talk Package)
Default Value	N

HOLD_PACKAGE

Value Format	Boolean
---------------------	---------

Description	Specifies whether to enable the Click to Hold function. Note <ul style="list-style-type: none"> When this parameter is set to "Y", "hold" is added to the Allow-Events header.
Value Range	<ul style="list-style-type: none"> Y (Enable Hold Package) N (Disable Hold Package)
Default Value	N

HOLD_RECALL_TIM

Value Format	Integer
Description	Specifies the duration of the hold recall timer. If set to "0", the function is disabled.
Value Range	0–240 (0: Disable)
Default Value	60

AUTO_ANS_RING_TIM

Value Format	Integer
Description	Specifies the number of seconds a phone in Auto Answer mode will ring before a conversation is established automatically when it receives a call.
Value Range	0–15
Default Value	5

RINGING_OFF_SETTING_ENABLE

Value Format	Boolean
Description	Specifies whether incoming call ringing can be turned off for the phone. If disabled, users cannot prevent incoming calls from ringing.
Value Range	<ul style="list-style-type: none"> Y (Enable Ringing Off setting) N (Disable Ringing Off setting)
Default Value	Y

AUTO_CALL_HOLD

Value Format	Boolean
Description	Selects whether calls are disconnected or held when a DN button is pressed while having a conversation.

Value Range	<ul style="list-style-type: none"> • \mathcal{Y} (Enable Auto Call Hold) • \mathcal{N} (Disable Auto Call Hold)
Default Value	\mathcal{N}

REDIALKEY_CALLLOG_ENABLE

Value Format	Boolean
Description	Specifies whether the call log is displayed when [Redial] is tapped while on-hook.
Value Range	<ul style="list-style-type: none"> • \mathcal{Y} (Displays outgoing call log when [Redial] is tapped.) • \mathcal{N} (Redials last-called telephone number when [Redial] is tapped.)
Default Value	\mathcal{N}

ONHOOK_TRANSFER_ENABLE

Value Format	Boolean
Description	<p>Specifies whether transfer operations are permitted while on-hook.</p> <p>Note</p> <ul style="list-style-type: none"> • When the mode for users with difficulties operating the touch display directly (Accessibility mode) is enabled through phone user interface programming, this setting is disabled.
Value Range	<ul style="list-style-type: none"> • \mathcal{Y} (Enable On-hook Transfer) • \mathcal{N} (Disable On-hook Transfer)
Default Value	\mathcal{Y}

DISCONNECTION_MODE

Value Format	Integer
Description	Selects the reorder tone (ROT) or busy tone (BT) when a dial operation fails.
Value Range	1–2 – 1: Mode1 (ROT) – 2: Mode2 (BT)
Default Value	1

TONE_LEN_DISCONNECT_HANDSET

Value Format	Integer
Description	Specifies the duration, in seconds, that a disconnect tone will be heard when the other party ends a call and the handset is being used.

Value Range	1–15
Default Value	10

TONE_LEN_DISCONNECT_HANDSFREE

Value Format	Integer
Description	Specifies the duration, in seconds, that a disconnect tone will be heard while in hands-free mode when the other party ends a call.
Value Range	1–15
Default Value	3

KEY_PAD_TONE

Value Format	Boolean
Description	Selects whether a tone is heard in response to key presses. Note <ul style="list-style-type: none"> This setting does not affect the iWnn IME Keyboard. For details about available keyboards, refer to the Operating Instructions on the Panasonic Web site (→ see Introduction). If touch tones or selection tones are configured through phone user interface programming, changes to this setting are ignored.
Value Range	<ul style="list-style-type: none"> Y (Enable Key Pad Tone) N (Disable Key Pad Tone)
Default Value	Y

DDI_ICD_GROUP_DISPLAY

Value Format	Integer
Description	Specifies the caller information or called party information displayed on the unit when an incoming call is received.
Value Range	<ul style="list-style-type: none"> 0: Only the caller name is displayed. 1: The caller name is prioritized. 2: The ICD (Incoming Call Distribution)/DDI (Direct Dialing In) group name is prioritized. 3: Only the ICD/DDI group name is displayed.
Default Value	1

5.6.2 Tone Settings

DIAL_TONE1_FRQ

Value Format	Comma-separated Integer
Description	Specifies the dual-tone frequencies, in hertz, of Dial Tone 1 using 2 whole numbers separated by a comma.
Value Range	0, 200–2000 (0: No tone)
Default Value	350,440
Web User Interface Reference	Tone Frequencies (Page 117)

DIAL_TONE1_GAIN

Value Format	Integer
Description	Specifies the gain, in decibels, of Dial Tone 1.
Value Range	-24–6
Default Value	0

DIAL_TONE1_TIMING

Value Format	Comma-separated Integer
Description	Specifies the pattern, in milliseconds, of Dial Tone 1 using up to 10 whole numbers (off 1, on 1, off 2, on 2...) separated by commas. Note <ul style="list-style-type: none"> It is recommended that you set a value of 60 milliseconds or more for the first value (off 1).
Value Range	0–16000 (0: Infinite time)
Default Value	60,0
Web User Interface Reference	Tone Timings (Page 117)

DIAL_TONE2_FRQ

Value Format	Comma-separated Integer
Description	Specifies the dual-tone frequencies, in hertz, of Dial Tone 2 using 2 whole numbers separated by a comma.
Value Range	0, 200–2000 (0: No tone)
Default Value	350,440

DIAL_TONE2_GAIN

Value Format	Integer
Description	Specifies the gain, in decibels, of Dial Tone 2.
Value Range	-24–6
Default Value	0

DIAL_TONE2_TIMING

Value Format	Comma-separated Integer
Description	Specifies the pattern, in milliseconds, of Dial Tone 2 using up to 10 whole numbers (off 1, on 1, off 2, on 2...) separated by commas. Note <ul style="list-style-type: none"> It is recommended that you set a value of 60 milliseconds or more for the first value (off 1).
Value Range	0–16000 (0: Infinite time)
Default Value	60,0

DIAL_TONE4_FRQ

Value Format	Comma-separated Integer
Description	Specifies the dual-tone frequencies, in hertz, of Dial Tone 4 (stutter dial tones) to notify that a voice mail is waiting, using 4 whole numbers separated by a comma.
Value Range	0, 200–2000 (0: No tone)
Default Value	350,440
Web User Interface Reference	Tone Frequencies (Page 119)

DIAL_TONE4_GAIN

Value Format	Integer
Description	Specifies the gain, in decibels, of Dial Tone 4 (stutter-type dial tone).
Value Range	-24–6
Default Value	0

DIAL_TONE4_TIMING

Value Format	Comma-separated Integer
---------------------	-------------------------

Description	Specifies the pattern, in milliseconds, of Dial Tone 4 (stutter dial tones) to notify that a voice mail is waiting, using up to 22 whole numbers (off 1, on 1, off 2, on 2...) separated by commas. Note <ul style="list-style-type: none"> It is recommended that you set a value of 560 milliseconds or more for the first value (off 1).
Value Range	0–16000 (0: Infinite time)
Default Value	560,100,0
Web User Interface Reference	Tone Timings (Page 119)

BUSY_TONE_FRQ

Value Format	Comma-separated Integer
Description	Specifies the dual-tone frequencies, in hertz, of busy tones using 2 whole numbers separated by a comma.
Value Range	0, 200–2000 (0: No tone)
Default Value	480,620
Web User Interface Reference	Tone Frequencies (Page 118)

BUSY_TONE_GAIN

Value Format	Integer
Description	Specifies the gain, in decibels, of the busy tone.
Value Range	-24–6
Default Value	0

BUSY_TONE_TIMING

Value Format	Comma-separated Integer
Description	Specifies the pattern, in milliseconds, of busy tones using up to 10 whole numbers (off 1, on 1, off 2, on 2...) separated by commas. Note <ul style="list-style-type: none"> It is recommended that you set a value of 60 milliseconds or more for the first value (off 1).
Value Range	0–16000 (0: Infinite time)
Default Value	60,500,440
Web User Interface Reference	Tone Timings (Page 118)

REORDER_TONE_FRQ

Value Format	Comma-separated Integer
Description	Specifies the dual-tone frequencies, in hertz, of reorder tones using 2 whole numbers separated by a comma.
Value Range	0, 200–2000 (0: No tone)
Default Value	480,620
Web User Interface Reference	Tone Frequencies (Page 120)

REORDER_TONE_GAIN

Value Format	Integer
Description	Specifies the gain, in decibels, of the reorder tone.
Value Range	-24–6
Default Value	0

REORDER_TONE_TIMING

Value Format	Comma-separated Integer
Description	Specifies the pattern, in milliseconds, of reorder tones using up to 10 whole numbers (off 1, on 1, off 2, on 2...) separated by commas. Note <ul style="list-style-type: none"> It is recommended that you set a value of 60 milliseconds or more for the first value (off 1).
Value Range	0–16000 (0: Infinite time)
Default Value	60,250,190
Web User Interface Reference	Tone Timings (Page 120)

RINGBACK_TONE_FRQ

Value Format	Comma-separated Integer
Description	Specifies the dual-tone frequencies, in hertz, of ringback tones using 2 whole numbers separated by a comma.
Value Range	0, 200–2000 (0: No tone)
Default Value	440,480
Web User Interface Reference	Tone Frequencies (Page 118)

RINGBACK_TONE_GAIN

Value Format	Integer
Description	Specifies the gain, in decibels, of the ringback tone.
Value Range	-24–6
Default Value	0

RINGBACK_TONE_TIMING

Value Format	Comma-separated Integer
Description	Specifies the pattern, in milliseconds, of ringback tones using up to 10 whole numbers (off 1, on 1, off 2, on 2...) separated by commas. Note <ul style="list-style-type: none"> It is recommended that you set a value of 60 milliseconds or more for the first value (off 1).
Value Range	0–16000 (0: Infinite time)
Default Value	60,2000,3940
Web User Interface Reference	Tone Timings (Page 119)

HOLD_ALARM_FRQ

Value Format	Comma-separated Integer
Description	Specifies the dual-tone frequencies, in hertz, of the hold alarm using 2 whole numbers separated by a comma.
Value Range	0, 200–2000 (0: No tone)
Default Value	425

HOLD_ALARM_GAIN

Value Format	Integer
Description	Specifies the gain, in decibels, of the hold alarm.
Value Range	-24–6
Default Value	0

HOLD_ALARM_TIMING

Value Format	Comma-separated Integer
Description	Specifies the pattern, in milliseconds, of the hold alarm using up to 10 whole numbers (on 1, off 1, on 2, off 2...) separated by commas.

Value Range	0–16000 (0: Infinite time)
Default Value	120,14880

CW_TONE1_FRQ

Value Format	Comma-separated Integer
Description	Specifies the dual-tone frequencies, in hertz, of call waiting tone 1 using 2 whole numbers separated by a comma.
Value Range	0, 200–2000 (0: No tone)
Default Value	425

CW_TONE1_GAIN

Value Format	Integer
Description	Specifies the gain, in decibels, of call waiting tone 1.
Value Range	-24–6
Default Value	0

CW_TONE1_TIMING

Value Format	Comma-separated Integer
Description	Specifies the pattern, in milliseconds, of call waiting tone 1 using up to 10 whole numbers (on 1, off 1, on 2, off 2...) separated by commas.
Value Range	0–16000 (0: Infinite time)
Default Value	120,120,120,120,120,14400

HOLD_TONE_FRQ

Value Format	Comma-separated Integer
Description	Specifies the dual-tone frequencies, in hertz, of the hold tone using 2 whole numbers separated by a comma.
Value Range	0, 200–2000 (0: No tone)
Default Value	425

HOLD_TONE_GAIN

Value Format	Integer
Description	Specifies the gain, in decibels, of the hold tone.

Value Range	-24–6
Default Value	0

HOLD_TONE_TIMING

Value Format	Comma-separated Integer
Description	Specifies the pattern, in milliseconds, of the hold tone using up to 10 whole numbers (off 1, on 1, off 2, on 2...) separated by commas. Note <ul style="list-style-type: none"> It is recommended that you set a value of 500 milliseconds or more for the first value (off 1).
Value Range	0–16000 (0: Infinite time)
Default Value	500,190,190,190,2890

5.6.3 Telephone Settings

DISPLAY_NAME_REPLACE

Value Format	Boolean
Description	Specifies whether the name saved in the phonebook is used in place of the name display if a matching entry is found.
Value Range	<ul style="list-style-type: none"> Y (Enable Display Name Replace) N (Disable Display Name Replace)
Default Value	Y

NUMBER_MATCHING_LOWER_DIGIT

Value Format	Integer
Description	Specifies the minimum number of digits with which to match a phonebook entry with an incoming call's caller ID. To specify exact matching of entire numbers only, specify "0" for this parameter and "NUMBER_MATCHING_UPPER_DIGIT".
Value Range	0–15
Default Value	7
Web User Interface Reference	Number Matching Lower Digit (Page 120)

NUMBER_MATCHING_UPPER_DIGIT

Value Format	Integer
---------------------	---------

Description	Specifies the maximum number of digits with which to match a phonebook entry with an incoming call's caller ID. To specify exact matching of entire numbers only, specify "0" for this parameter and "NUMBER_MATCHING_LOWER_DIGIT".
Value Range	0–15
Default Value	10
Web User Interface Reference	Number Matching Upper Digit (Page 121)

DISPLAY_DATE_PATTERN

Value Format	Integer
Description	Selects the display order pattern for the day and month of the date. Note <ul style="list-style-type: none"> If the time format or date format are configured through phone user interface programming, changes to this setting are ignored.
Value Range	0–2 – 0: Not specified – 1: DDMM – 2: MMDD
Default Value	0

DISPLAY_TIME_PATTERN

Value Format	Integer
Description	Selects the display type for the time (12- or 24-hour format). Note <ul style="list-style-type: none"> If the time format or date format are configured through phone user interface programming, changes to this setting are ignored.
Value Range	0–2 – 0: Not specified – 1: 12H – 2: 24H
Default Value	0

DEFAULT_LANGUAGE

Value Format	String
---------------------	--------

Description	Selects the language to use for the menus and display items on the phone. Note <ul style="list-style-type: none"> If the language locale is configured through phone user interface programming, changes to this setting are ignored.
Value Range	Only the following values are available: <ul style="list-style-type: none"> en-US (English [US]) en-GB (English [UK]) de (German) fr (French) fr-CA (French [Canadian]) it (Italian) es (Spanish) nl (Dutch) ru (Russian) ja (Japanese)
Default Value	en-US

POUND_KEY_DELIMITER_ENABLE

Value Format	Boolean
Description	Specifies whether the # key is treated as a regular dialed digit or a delimiter, when dialed as or after the second digit.
Value Range	<ul style="list-style-type: none"> y (# is treated as the end of dialing delimiter) n (# is treated as a regular dialed digit)
Default Value	y

WALLPAPER_URI_HOME

Value Format	String
Description	Specifies the URI of the wallpaper of the unit's Home screen. Note <ul style="list-style-type: none"> Only a JPEG, PNG, GIF, or BMP format file that is 5 MB or less can be used.
Value Range	Max. 500 characters
Default Value	Empty string

WALLPAPER_URI_PHONE

Value Format	String
---------------------	--------

Description	Specifies the URI of the wallpaper of the unit's Phone screen. Note <ul style="list-style-type: none"> Only a JPEG, PNG, or GIF format file that is 5 MB or less can be used. (BMP format files cannot be used.)
Value Range	Max. 500 characters Note <ul style="list-style-type: none"> You can insert "b," (black) or "w," (white) before the URI to specify whether the other parts of the screen are a dark or light color.
Default Value	Empty string

LOGO_URI_PHONE

Value Format	String
Description	Specifies the URI of the logo of the unit's Phone screen. Note <ul style="list-style-type: none"> Only a JPEG, PNG, or GIF format file that is 5 MB or less can be used. (BMP format files cannot be used.)
Value Range	Max. 500 characters
Default Value	Empty string

5.6.4 Flexible Button Settings

FLEX_BUTTON_FACILITY_ACTx

Value Format	String
Description	Specifies a particular Facility Action for the flexible button. No facility action will be taken for the button if the string is empty or invalid.
Value Range	Only the following values are available: X_PANASONIC_IPTEL_DN, X_PANASONIC_IPTEL_HEADSET, X_PANASONIC_IPTEL_CONTACT, X_PANASONIC_IPTEL_ONETOUCH
Default Value	X_PANASONIC_IPTEL_DN

FLEX_BUTTON_FACILITY_ARGx

Value Format	String
Description	Optional argument associated with the specified Facility Action for the flexible button.

Value Range	Max. 32 characters Note <ul style="list-style-type: none"> • The value range differs depending on the flexible button set in "FLEX_BUTTON_FACILITY_ACTx", as follows: <ul style="list-style-type: none"> – X_PANASONIC_IPTTEL_DN: 1–32 (ringtone number), 1–6 (line number) – X_PANASONIC_IPTTEL_HEADSET: not available – X_PANASONIC_IPTTEL_CONTACT: 1–32 digit number – X_PANASONIC_IPTTEL_ONETOUCH: 1–32 digit number For details about flexible buttons, refer to the Operating Instructions on the Panasonic Web site (→ see Introduction).
Default Value	1,1

FLEX_BUTTON_LABELx

Value Format	String
Description	Specifies the message to be displayed on the screen when the flexible button is pressed. Note <ul style="list-style-type: none"> • You can use Unicode characters for this setting.
Value Range	Max. 10 characters or 30 bytes
Default Value	Empty string

5.7 VoIP Settings

5.7.1 Codec Settings

CODEC_G711_REQ

Value Format	Integer
Description	Specifies whether to set "PCMU" as a codec selection automatically when "CODEC_ENABLEx_n" is set to any codec selection other than "PCMU".
Value Range	<ul style="list-style-type: none"> • 0 (Do not set "PCMU") • 1 (Set "PCMU")
Default Value	1

CODEC_G729_PARAM

Value Format	Integer
Description	Specifies whether to add an attribute line, "a=fmtp:18 annexb=no", to SDP when "CODEC_ENABLEx_n" is set to "G729A".
Value Range	<ul style="list-style-type: none"> 0 (Do not add "a=fmtp:18 annexb=no") 1 (Add "a=fmtp:18 annexb=no")
Default Value	0

CODEC_ENABLEx_n

Parameter Name Example	CODEC_ENABLEx_1, CODEC_ENABLEx_2, ..., CODEC_ENABLEx_6
Value Format	Boolean
Description	<p>Specifies whether to enable the codec specified in the parameter list.</p> <p>Note</p> <ul style="list-style-type: none"> The "x" character in the parameter title should be changed to one of the following numbers, according to the codec to be changed. <ul style="list-style-type: none"> 0: G.722 1: PCMA 3: G.729A 4: PCMU
Value Range	<ul style="list-style-type: none"> Y (Enable) N (Disable)
Default Value	Y
Web User Interface Reference	<ul style="list-style-type: none"> G722 (Enable) (Page 103) PCMA (Enable) (Page 104) G729A (Enable) (Page 104) PCMU (Enable) (Page 104)

CODEC_PRIORITYx_n

Parameter Name Example	CODEC_PRIORITYx_1, CODEC_PRIORITYx_2, ..., CODEC_PRIORITYx_6
Value Format	Integer

Description	Specifies the priority order for the codec. Note <ul style="list-style-type: none"> • The "x" character in the parameter title should be changed to one of the following numbers, according to the codec to be changed. <ul style="list-style-type: none"> – 0: G.722 – 1: PCMA – 3: G.729A – 4: PCMU • The lower the set value, the higher the priority.
Value Range	1–255
Default Value	1
Web User Interface Reference	<ul style="list-style-type: none"> • G722 (Priority) (Page 103) • PCMA (Priority) (Page 104) • G729A (Priority) (Page 104) • PCMU (Priority) (Page 105)

5.7.2 RTP Settings

DSCP_RTP_n

Parameter Name Example	DSCP_RTP_1, DSCP_RTP_2, ..., DSCP_RTP_6
Value Format	Integer
Description	Selects the DSCP level of DiffServ applied to RTP packets.
Value Range	0–63
Default Value	0
Web User Interface Reference	RTP Packet QoS (DSCP) (Page 100)

DSCP_RTCP_n

Parameter Name Example	DSCP_RTCP_1, DSCP_RTCP_2, ..., DSCP_RTCP_6
Value Format	Integer
Description	Selects the DSCP level of DiffServ applied to RTCP packets.
Value Range	0–63
Default Value	0
Web User Interface Reference	RTCP Packet QoS (DSCP) (Page 100)

RTCP_INTVL_n

Parameter Name Example	RTCP_INTVL_1, RTCP_INTVL_2, ..., RTCP_INTVL_6
Value Format	Integer
Description	Specifies the interval, in seconds, between RTCP packets.
Value Range	5–65535
Default Value	5
Web User Interface Reference	RTCP Interval (Page 101)

MAX_DELAY_n

Parameter Name Example	MAX_DELAY_1, MAX_DELAY_2, ..., MAX_DELAY_6
Value Format	Integer
Description	Specifies the maximum delay, in 10-millisecond units, of the jitter buffer.
Value Range	3–50 (× 10 ms) Note <ul style="list-style-type: none"> • This setting is subject to the following conditions: <ul style="list-style-type: none"> – This value must be greater than "NOM_DELAY" – This value must be greater than "MIN_DELAY" – "NOM_DELAY" must be greater than or equal to "MIN_DELAY"
Default Value	20 (× 10 ms)
Web User Interface Reference	Maximum Delay (Page 101)

MIN_DELAY_n

Parameter Name Example	MIN_DELAY_1, MIN_DELAY_2, ..., MIN_DELAY_6
Value Format	Integer
Description	Specifies the minimum delay, in 10-millisecond units, of the jitter buffer.
Value Range	1 or 2 (× 10 ms) Note <ul style="list-style-type: none"> • This setting is subject to the following conditions: <ul style="list-style-type: none"> – This value must be less than or equal to "NOM_DELAY" – This value must be less than "MAX_DELAY" – "MAX_DELAY" must be greater than "NOM_DELAY"
Default Value	2 (× 10 ms)
Web User Interface Reference	Minimum Delay (Page 101)

NOM_DELAY_n

Parameter Name Example	NOM_DELAY_1, NOM_DELAY_2, ..., NOM_DELAY_6
Value Format	Integer
Description	Specifies the initial delay, in 10-millisecond units, of the jitter buffer.
Value Range	1–7 (× 10 ms) Note <ul style="list-style-type: none"> This setting is subject to the following conditions: <ul style="list-style-type: none"> This value must be greater than or equal to "MIN_DELAY" This value must be less than "MAX_DELAY"
Default Value	2 (× 10 ms)
Web User Interface Reference	Initial Delay (Page 102)

RTP_PORT_MIN

Value Format	Integer
Description	Specifies the lowest port number that the unit will use for RTP packets. Note <ul style="list-style-type: none"> If port numbers are specified in [Channel 1–25] in 4.4.5.3 External RTP Port in the Web user interface, this setting is ignored and the corresponding external RTP port is enabled.
Value Range	1024–48750 (even number only) Note <ul style="list-style-type: none"> The value for this setting must be less than or equal to "RTP_PORT_MAX" - 400. Changing this setting may affect the number of simultaneous calls that can be made. Therefore, when setting this parameter, be aware that the maximum number of necessary ports can be calculated as shown below: No. of lines × No. of channels × 2 × 10 (No. of terminals)
Default Value	16000
Web User Interface Reference	Minimum RTP Port Number (Page 98)

RTP_PORT_MAX

Value Format	Integer
---------------------	---------

Description	Specifies the highest port number that the unit will use for RTP packets. Note <ul style="list-style-type: none"> If port numbers are specified in [Channel 1–25] in 4.4.5.3 External RTP Port in the Web user interface, this setting is ignored and the corresponding external RTP port is enabled.
Value Range	1424–49150 (even number only) Note <ul style="list-style-type: none"> The value for this setting must be greater than or equal to "RTP_PORT_MIN" + 400. Changing this setting may affect the number of simultaneous calls that can be made. Therefore, when setting this parameter, be aware that the maximum number of necessary ports can be calculated as shown below: No. of lines × No. of channels × 2 × 10 (No. of terminals)
Default Value	20000
Web User Interface Reference	Maximum RTP Port Number (Page 99)

RTP_PTME

Value Format	Integer
Description	Specifies the interval, in milliseconds, between transmissions of RTP packets.
Value Range	<ul style="list-style-type: none"> 20 30 (not available with the G.722 codec) 40
Default Value	20
Web User Interface Reference	RTP Packet Time (Page 98)

RTCP_ENABLE_n

Parameter Name Example	RTCP_ENABLE_1, RTCP_ENABLE_2, ..., RTCP_ENABLE_6
Value Format	Boolean
Description	Selects whether to enable or disable RTCP (Real-Time Transport Control Protocol). For details, refer to RFC 3550.
Value Range	<ul style="list-style-type: none"> Y (Enable RTCP) N (Disable RTCP)
Default Value	N
Web User Interface Reference	RTCP Enable (Page 101)

RTCP_SEND_BY_SDP_n

Parameter Name Example	RTCP_SEND_BY_SDP_1, RTCP_SEND_BY_SDP_2, ..., RTCP_SEND_BY_SDP_6
Value Format	Integer
Description	Specifies whether to send RTCP signals by SDP (Session Description Protocol).
Value Range	0–1 <ul style="list-style-type: none"> – 0: Send RTCP signals using the value specified in "RTCP_INTVL_n", if the "RTCP_ENABLE_n" parameter is enabled. – 1: Send RTCP signals using the value specified in the SDP attribute "a=rtcp:".
Default Value	0

RTP_CLOSE_ENABLE_n

Parameter Name Example	RTP_CLOSE_ENABLE_1, RTP_CLOSE_ENABLE_2, ..., RTP_CLOSE_ENABLE_6
Value Format	Boolean
Description	Specifies whether to enable processing to close held RTP sockets.
Value Range	<ul style="list-style-type: none"> • y (Enable RTP Close) • n (Disable RTP Close)
Default Value	y

5.7.3 Miscellaneous VoIP Settings

OUTBANDDTMF_n

Parameter Name Example	OUTBANDDTMF_1, OUTBANDDTMF_2, ..., OUTBANDDTMF_6
Value Format	Boolean
Description	Specifies the method for transmitting DTMF tones.
Value Range	<ul style="list-style-type: none"> • y (Outband [use telephone-event]) • n (Inband) <p>Note</p> <ul style="list-style-type: none"> • If set to "y", DTMF tones will be sent through SDP, compliant with RFC 2833. • If set to "n", DTMF tones will be encoded in the RTP stream.
Default Value	y
Web User Interface Reference	DTMF Type (Page 102)

DTMF_RELAY_n

Parameter Name Example	DTMF_RELAY_1, DTMF_RELAY_2, ..., DTMF_RELAY_6
Value Format	Boolean
Description	Selects whether DTMF tones are sent in the SIP INFO message.
Value Range	<ul style="list-style-type: none"> • Y • N <p>Note</p> <ul style="list-style-type: none"> • If set to "Y", DTMF tones will be sent in the SIP INFO message. • If set to "N", the method selected in "OUTBANDDTMF_n" will be used.
Default Value	N
Web User Interface Reference	DTMF Relay (Page 102)

TELEVENT_PAYLOAD

Value Format	Integer
Description	Specifies the RFC 2833 payload type for DTMF tones. <p>Note</p> <ul style="list-style-type: none"> • This setting is available only when "OUTBANDDTMF_n" is set to "Y".
Value Range	96–127
Default Value	101
Web User Interface Reference	Telephone-event Payload Type (Page 99)

RFC2543_HOLD_ENABLE_n

Parameter Name Example	RFC2543_HOLD_ENABLE_1, RFC2543_HOLD_ENABLE_2, ..., RFC2543_HOLD_ENABLE_6
Value Format	Boolean
Description	Specifies whether to enable the RFC 2543 Call Hold feature on this line.
Value Range	<ul style="list-style-type: none"> • Y (Enable RFC 2543 Call Hold) • N (Disable RFC 2543 Call Hold) <p>Note</p> <ul style="list-style-type: none"> • If set to "Y", the "c=0.0.0.0" syntax will be set in SDP when sending a re-INVITE message to hold the call. • If set to "N", the "c=x.x.x.x" syntax will be set in SDP.
Default Value	Y

Web User Interface Reference	Supports RFC 2543 (c=0.0.0.0) (Page 103)
------------------------------	--

DTMF_SIGNAL_LEN

Value Format	Integer
Description	Specifies the length of the DTMF signal, in milliseconds.
Value Range	60–200 (in 5 millisecond units)
Default Value	180

DTMF_INTDIGIT_TIM

Value Format	Integer
Description	Specifies the interval, in milliseconds, between DTMF signals.
Value Range	60–200 (in 5 millisecond units)
Default Value	90

5.8 Line Settings

5.8.1 Call Control Settings

DISPLAY_NAME_n

Parameter Name Example	DISPLAY_NAME_1, DISPLAY_NAME_2, ..., DISPLAY_NAME_6
Value Format	String
Description	Specifies the name to display as the caller on the other party's phone when you make a call.
Value Range	Max. 24 characters Note • You can use Unicode characters for this setting.
Default Value	Empty string
Web User Interface Reference	Display Name (Page 109)

VM_NUMBER_n

Parameter Name Example	VM_NUMBER_1, VM_NUMBER_2, ..., VM_NUMBER_6
Value Format	String

Description	Specifies the phone number used to access the voice mail server. Note <ul style="list-style-type: none"> Your phone system must support voice mail.
Value Range	Max. 32 characters
Default Value	Empty string
Web User Interface Reference	Voice Mail Access Number (Page 109)

DIAL_PLAN_n

Parameter Name Example	DIAL_PLAN_1, DIAL_PLAN_2, ..., DIAL_PLAN_6
Value Format	String
Description	Specifies a dial format, such as specific phone numbers, that control which numbers can be dialed or how to handle the call when making a call. For details, see 6.6 Dial Plan .
Value Range	Max. 500 characters
Default Value	Empty string
Web User Interface Reference	Dial Plan (max 500 columns) (Page 111)

DIAL_PLAN_NOT_MATCH_ENABLE_n

Parameter Name Example	DIAL_PLAN_NOT_MATCH_ENABLE_1, DIAL_PLAN_NOT_MATCH_ENABLE_2, ..., DIAL_PLAN_NOT_MATCH_ENABLE_6
Value Format	Boolean
Description	Specifies whether to enable dial plan filtering so that a call is not made when the dialed number does not match any of the dial formats specified in "DIAL_PLAN_n".
Value Range	<ul style="list-style-type: none"> Y (Enable dial plan filtering) N (Disable dial plan filtering) Note <ul style="list-style-type: none"> If set to "Y", the dialed number will not be sent to the line when the number dialed by the user does not match any of the dial formats specified in the dial plan. If set to "N", the dialed number will be sent to the line, even if the number dialed by the user does not match any of the dial formats specified in the dial plan.
Default Value	N
Web User Interface Reference	Call Even If Dial Plan Does Not Match (Page 111)

SHARED_CALL_ENABLE_n

Parameter Name Example	SHARED_CALL_ENABLE_1, SHARED_CALL_ENABLE_2, ..., SHARED_CALL_ENABLE_6
Value Format	Boolean
Description	<p>Specifies whether to enable the Shared Call feature of the SIP server, which is used to share one line among the units.</p> <p>Note</p> <ul style="list-style-type: none"> You cannot set both "SHARED_CALL_ENABLE_n" and "FWD_DND_SYNCHRO_ENABLE_n" to "Y" at the same time. Availability depends on your phone system.
Value Range	<ul style="list-style-type: none"> Y (Enable shared call) N (Disable shared call) <p>Note</p> <ul style="list-style-type: none"> If set to "Y", the SIP server will control the line by using a shared-call signaling method. If set to "N", the SIP server will control the line by using a standard signaling method.
Default Value	N
Web User Interface Reference	Enable Shared Call (Page 110)

FWD_DND_SYNCHRO_ENABLE_n

Parameter Name Example	FWD_DND_SYNCHRO_ENABLE_1, FWD_DND_SYNCHRO_ENABLE_2, ..., FWD_DND_SYNCHRO_ENABLE_6
Value Format	Boolean
Description	<p>Specifies whether to synchronize the Do Not Disturb and Call Forward settings, configured via the Web user interface or phone user interface, between the unit and the portal server that is provided by your phone system dealer.</p> <p>Note</p> <ul style="list-style-type: none"> Even if you specify "Y", this feature may not function properly if your phone system does not support it. Before you configure this setting, consult your phone system dealer. You cannot set both "SHARED_CALL_ENABLE_n" and "FWD_DND_SYNCHRO_ENABLE_n" to "Y" at the same time.
Value Range	<ul style="list-style-type: none"> Y (Enable Do Not Disturb/Call Forward synchronization) N (Disable Do Not Disturb/Call Forward synchronization)
Default Value	N
Web User Interface Reference	Synchronize Do Not Disturb and Call Forward (Page 110)

RESOURCELIST_URI_n

Parameter Name Example	RESOURCELIST_URI_1, RESOURCELIST_URI_2, ..., RESOURCELIST_URI_6
Value Format	String
Description	<p>Specifies the Uniform Resource Identifier string for the resource list, which consists of "sip:", a user part, the "@" symbol, and a host part, for example, "sip:user@example.com". For details, refer to RFC 4662.</p> <p>Note</p> <ul style="list-style-type: none"> In a SIP URI, the user part ("user" in the example above) can contain up to 63 characters, and the host part ("example.com" in the example above) can contain up to 127 characters. When the BLF feature is assigned to a flexible button, it may be necessary to specify this parameter depending on your phone system. For details about flexible buttons, see 6.1 Registering One-touch Buttons and BLF Buttons.
Value Range	Max. 195 characters (except ", &, ', :, ;, <, >, and space)
Default Value	Empty string
Web User Interface Reference	Resource List URI (Page 111)

CW_ENABLE_n

Parameter Name Example	CW_ENABLE_1, CW_ENABLE_2, ..., CW_ENABLE_6
Value Format	Boolean
Description	Specifies whether automatic call waiting is enabled.
Value Range	<ul style="list-style-type: none"> Y (Enable Call Waiting) N (Disable Call Waiting)
Default Value	Y

FLASH_RECALL_TERMINATE

Value Format	Boolean
Description	Selects the function of the [Flash] key during a conversation.
Value Range	<ul style="list-style-type: none"> Y (Terminate) N (EFA)
Default Value	Y
Web User Interface Reference	Flash/Recall Button (Page 107)

FLASHHOOK_CONTENT_TYPE

Value Format	String
Description	Specifies the type of signal sent when sending a flash hook event.
Value Range	<ul style="list-style-type: none"> • <code>Signal</code> • <code>flashhook</code>
Default Value	<code>Signal</code>
Web User Interface Reference	Flash Hook Event (Page 108)

VOICE_MESSAGE_AVAILABLE

Value Format	Boolean
Description	Selects how the existence of voice messages is determined when a "Messages-Waiting: yes" message is received.
Value Range	<ul style="list-style-type: none"> • <code>y</code> (Determines that voice messages exist when "Messages-Waiting: yes" is received with a "Voice-Message" line included.) • <code>n</code> (Determines that voice messages exist when "Messages-Waiting: yes" is received even without a "Voice-Message" line included.)
Default Value	<code>y</code>

5.8.2 SIP Settings

SIP_USER_AGENT

Value Format	String
Description	Specifies the text string to send as the user agent in the headers of SIP messages.
Value Range	<p>Max. 40 characters</p> <p>Note</p> <ul style="list-style-type: none"> • An empty string is not allowed. • If "<code>{mac}</code>" is included in this parameter, it will be replaced with the unit's MAC address in lower-case. • If "<code>{MAC}</code>" is included in this parameter, it will be replaced with the unit's MAC address in upper-case. • If "<code>{MODEL}</code>" is included in this parameter, it will be replaced with the unit's model name. • If "<code>{fwver}</code>" is included in this parameter, it will be replaced with the firmware version of the unit.
Default Value	Panasonic_{MODEL}/{fwver} ({mac})
Web User Interface Reference	SIP User Agent (Page 88)

PHONE_NUMBER_n

Parameter Name Example	PHONE_NUMBER_1, PHONE_NUMBER_2, ..., PHONE_NUMBER_6
Value Format	String
Description	Specifies the phone number to use as the user ID required for registration to the SIP registrar server. Note <ul style="list-style-type: none"> When registering using a user ID that is not a phone number, you should use the "SIP_URI_n" setting.
Value Range	Max. 32 characters
Default Value	Empty string
Web User Interface Reference	Phone Number (Page 89)

SIP_URI_n

Parameter Name Example	SIP_URI_1, SIP_URI_2, ..., SIP_URI_6
Value Format	String
Description	Specifies the unique ID used by the SIP registrar server, which consists of "sip:", a user part, the "@" symbol, and a host part, for example, "sip:user@example.com". Note <ul style="list-style-type: none"> When registering using a user ID that is not a phone number, you should use this setting. In a SIP URI, the user part ("user" in the example above) can contain up to 63 characters, and the host part ("example.com" in the example above) can contain up to 127 characters.
Value Range	Max. 195 characters (except ", &, ', :, ;, <, >, and space)
Default Value	Empty string
Web User Interface Reference	SIP URI (Page 89)

LINE_ENABLE_n

Parameter Name Example	LINE_ENABLE_1, LINE_ENABLE_2, ..., LINE_ENABLE_6
Value Format	String
Description	Specifies whether a line is enabled or disabled. Note <ul style="list-style-type: none"> Even when this parameter is enabled, if the "PROFILE_ENABLEn" parameter is disabled, the line will be disabled.

Value Range	<ul style="list-style-type: none"> • Disabled • Enabled
Default Value	Enabled

PROFILE_ENABLEn

Parameter Name Example	PROFILE_ENABLE1, PROFILE_ENABLE2, ..., PROFILE_ENABLE6
Value Format	String
Description	<p>Specifies whether a line is enabled or disabled.</p> <p>Note</p> <ul style="list-style-type: none"> • Even when this parameter is enabled, if the "LINE_ENABLE_n" parameter is disabled, the line will be disabled.
Value Range	<ul style="list-style-type: none"> • Disabled • Enabled
Default Value	Enabled

SIP_AUTHID_n

Parameter Name Example	SIP_AUTHID_1, SIP_AUTHID_2, ..., SIP_AUTHID_6
Value Format	String
Description	Specifies the authentication ID required to access the SIP server.
Value Range	Max. 64 characters (except ", &, ', :, <, >, and space)
Default Value	Empty string
Web User Interface Reference	Authentication ID (Page 92)

SIP_PASS_n

Parameter Name Example	SIP_PASS_1, SIP_PASS_2, ..., SIP_PASS_6
Value Format	String
Description	Specifies the authentication password used to access the SIP server.
Value Range	Max. 64 characters (except ", &, ', :, <, >, and space)
Default Value	Empty string
Web User Interface Reference	Authentication Password (Page 92)

SIP_SRC_PORT_n

Parameter Name Example	SIP_SRC_PORT_1, SIP_SRC_PORT_2, ..., SIP_SRC_PORT_6
Value Format	Integer
Description	Specifies the source port number used by the unit for SIP communication.
Value Range	1024–49151
Default Value	5060 (for SIP_SRC_PORT_1) 5070 (for SIP_SRC_PORT_2) 5080 (for SIP_SRC_PORT_3) 5090 (for SIP_SRC_PORT_4) 5100 (for SIP_SRC_PORT_5) 5110 (for SIP_SRC_PORT_6)
Web User Interface Reference	Source Port (Page 91)

SIP_PRXY_ADDR_n

Parameter Name Example	SIP_PRXY_ADDR_1, SIP_PRXY_ADDR_2, ..., SIP_PRXY_ADDR_6
Value Format	String
Description	Specifies the IP address or FQDN of the SIP proxy server.
Value Range	Max. 127 characters (IP address in dotted-decimal notation or FQDN)
Default Value	Empty string
Web User Interface Reference	Proxy Server Address (Page 90)

SIP_PRXY_PORT_n

Parameter Name Example	SIP_PRXY_PORT_1, SIP_PRXY_PORT_2, ..., SIP_PRXY_PORT_6
Value Format	Integer
Description	Specifies the port number to use for communication with the SIP proxy server.
Value Range	1–65535
Default Value	5060
Web User Interface Reference	Proxy Server Port (Page 90)

SIP_RGSTR_ADDR_n

Parameter Name Example	SIP_RGSTR_ADDR_1, SIP_RGSTR_ADDR_2, ..., SIP_RGSTR_ADDR_6
Value Format	String

Description	Specifies the IP address or FQDN of the SIP registrar server.
Value Range	Max. 127 characters (IP address in dotted-decimal notation or FQDN)
Default Value	Empty string
Web User Interface Reference	Registrar Server Address (Page 89)

SIP_RGSTR_PORT_n

Parameter Name Example	SIP_RGSTR_PORT_1, SIP_RGSTR_PORT_2, ..., SIP_RGSTR_PORT_6
Value Format	Integer
Description	Specifies the port number to use for communication with the SIP registrar server.
Value Range	1–65535
Default Value	5060
Web User Interface Reference	Registrar Server Port (Page 89)

SIP_SVCDOMAIN_n

Parameter Name Example	SIP_SVCDOMAIN_1, SIP_SVCDOMAIN_2, ..., SIP_SVCDOMAIN_6
Value Format	String
Description	Specifies the domain name provided by your phone system dealer. The domain name is the part of the SIP URI that comes after the "@" symbol.
Value Range	Max. 127 characters
Default Value	Empty string
Web User Interface Reference	Service Domain (Page 91)

REG_EXPIRE_TIME_n

Parameter Name Example	REG_EXPIRE_TIME_1, REG_EXPIRE_TIME_2, ..., REG_EXPIRE_TIME_6
Value Format	Integer
Description	Specifies the length of time, in seconds, that the registration remains valid. This value is set in the "Expires" header of the REGISTER request.
Value Range	1–4294967295
Default Value	3600

REG_INTERVAL_RATE_n

Parameter Name Example	REG_INTERVAL_RATE_1, REG_INTERVAL_RATE_2, ..., REG_INTERVAL_RATE_6
Value Format	Integer
Description	Specifies the percentage of the "expires" value after which to refresh registration by sending a new REGISTER message in the same dialog.
Value Range	1–100
Default Value	90

SIP_SESSION_TIME_n

Parameter Name Example	SIP_SESSION_TIME_1, SIP_SESSION_TIME_2, ..., SIP_SESSION_TIME_6
Value Format	Integer
Description	Specifies the length of time, in seconds, that the unit waits before terminating SIP sessions when no reply to repeated requests is received. For details, refer to RFC 4028.
Value Range	0, 60–65535 (0: Disable)
Default Value	0
Web User Interface Reference	Supports Session Timer (RFC 4028) (Page 96)

SIP_SESSION_METHOD_n

Parameter Name Example	SIP_SESSION_METHOD_1, SIP_SESSION_METHOD_2, ..., SIP_SESSION_METHOD_6
Value Format	Integer
Description	Selects the refreshing method of SIP sessions.
Value Range	0–2 – 0: reINVITE – 1: UPDATE – 2: AUTO
Default Value	0

DSCP_SIP_n

Parameter Name Example	DSCP_SIP_1, DSCP_SIP_2, ..., DSCP_SIP_6
Value Format	Integer
Description	Selects the DSCP level of DiffServ applied to SIP packets.
Value Range	0–63

Default Value	0
Web User Interface Reference	SIP Packet QoS (DSCP) (Page 95)

SIP_2NDPROXY_ADDR_n

Parameter Name Example	SIP_2NDPROXY_ADDR_1, SIP_2NDPROXY_ADDR_2, ..., SIP_2NDPROXY_ADDR_6
Value Format	String
Description	Specifies the IP address of the secondary SIP proxy server. Note <ul style="list-style-type: none"> This setting is available only when "SIP_PRXY_ADDR_n" is specified in IP address notation.
Value Range	IP address in dotted-decimal notation
Default Value	Empty string

SIP_2NDPROXY_PORT_n

Parameter Name Example	SIP_2NDPROXY_PORT_1, SIP_2NDPROXY_PORT_2, ..., SIP_2NDPROXY_PORT_6
Value Format	Integer
Description	Specifies the port number to use for communication with the secondary SIP proxy server.
Value Range	1–65535
Default Value	5060

SIP_2NDRGSTR_ADDR_n

Parameter Name Example	SIP_2NDRGSTR_ADDR_1, SIP_2NDRGSTR_ADDR_2, ..., SIP_2NDRGSTR_ADDR_6
Value Format	String
Description	Specifies the IP address of the secondary SIP registrar server. Note <ul style="list-style-type: none"> This setting is available only when "SIP_RGSTR_ADDR_n" is specified in IP address notation.
Value Range	IP address in dotted-decimal notation
Default Value	Empty string

SIP_2NDRGSTR_PORT_n

Parameter Name Example	SIP_2NDRGSTR_PORT_1, SIP_2NDRGSTR_PORT_2, ..., SIP_2NDRGSTR_PORT_6
Value Format	Integer
Description	Specifies the port number to use for communication with the secondary SIP registrar server.
Value Range	1–65535
Default Value	5060

SIP_TIMER_T1_n

Parameter Name Example	SIP_TIMER_T1_1, SIP_TIMER_T1_2, ..., SIP_TIMER_T1_6
Value Format	Integer
Description	Specifies the default interval, in milliseconds, between transmissions of SIP messages. For details, refer to RFC 3261.
Value Range	<ul style="list-style-type: none"> • 250 • 500 • 1000 • 2000 • 4000
Default Value	500
Web User Interface Reference	T1 Timer (Page 94)

SIP_TIMER_T2_n

Parameter Name Example	SIP_TIMER_T2_1, SIP_TIMER_T2_2, ..., SIP_TIMER_T2_6
Value Format	Integer
Description	Specifies the maximum interval, in seconds, between transmissions of SIP messages. For details, refer to RFC 3261.
Value Range	<ul style="list-style-type: none"> • 2 • 4 • 8 • 16 • 32
Default Value	4
Web User Interface Reference	T2 Timer (Page 94)

SIP_TIMER_T4_n

Parameter Name Example	SIP_TIMER_T4_1, SIP_TIMER_T4_2, ..., SIP_TIMER_T4_6
Value Format	Integer
Description	Specifies the maximum period, in seconds, that a message can remain on the network.
Value Range	<ul style="list-style-type: none"> • 0 • 1 • 2 • 3 • 4 • 5
Default Value	0

SIP_FOVR_NORSP_n

Parameter Name Example	SIP_FOVR_NORSP_1, SIP_FOVR_NORSP_2, ..., SIP_FOVR_NORSP_6
Value Format	Boolean
Description	Specifies whether to perform the fail-over process when the unit detects that the SIP server is not replying to SIP message.
Value Range	<ul style="list-style-type: none"> • y (Enable fail-over) • n (Disable fail-over) <p>Note</p> <ul style="list-style-type: none"> • If set to "y", the unit will try to use the other SIP servers via the DNS SRV and A records. • If set to "n", the unit will not try to use the other SIP servers.
Default Value	y

SIP_FOVR_MAX_n

Parameter Name Example	SIP_FOVR_MAX_1, SIP_FOVR_MAX_2, ..., SIP_FOVR_MAX_6
Value Format	Integer
Description	Specifies the maximum number of servers (including the first [normal] server) used in the fail-over process.
Value Range	1–4
Default Value	4

SIP_REFRESHER_n

Parameter Name Example	SIP_REFRESHER_1, SIP_REFRESHER_2, ..., SIP_REFRESHER_6
Value Format	Integer
Description	Specifies whether to add the refresher parameter for Session Expire in SIP INVITE.
Value Range	0–2 <ul style="list-style-type: none"> – 0: Do not add the refresher parameter – 1: Add the refresher parameter with the value "UAS" – 2: Add the refresher parameter with the value "UAC"
Default Value	0

SIP_DNSSRV_ENA_n

Parameter Name Example	SIP_DNSSRV_ENA_1, SIP_DNSSRV_ENA_2, ..., SIP_DNSSRV_ENA_6
Value Format	Boolean
Description	Specifies whether to request the DNS server to translate domain names into IP addresses using the SRV record.
Value Range	<ul style="list-style-type: none"> • Y (Enable DNS SRV lookup) • N (Disable DNS SRV lookup) <p>Note</p> <ul style="list-style-type: none"> • If set to "Y", the unit will perform a DNS SRV lookup for a SIP registrar server, SIP proxy server, SIP outbound proxy server, or SIP presence server. • If set to "N", the unit will not perform a DNS SRV lookup for a SIP registrar server, SIP proxy server, SIP outbound proxy server, or SIP presence server.
Default Value	Y
Web User Interface Reference	Enable DNS SRV lookup (Page 92)

SIP_UDP_SRV_PREFIX_n

Parameter Name Example	SIP_UDP_SRV_PREFIX_1, SIP_UDP_SRV_PREFIX_2, ..., SIP_UDP_SRV_PREFIX_6
Value Format	String
Description	Specifies a prefix to add to the domain name when performing a DNS SRV lookup using UDP.
	<p>Note</p> <ul style="list-style-type: none"> • This setting is available only when "SIP_DNSSRV_ENA_n" is set to "Y".

Value Range	Max. 32 characters
Default Value	_sip._udp.
Web User Interface Reference	SRV lookup Prefix for UDP (Page 93)

SIP_TCP_SRV_PREFIX_n

Parameter Name Example	SIP_TCP_SRV_PREFIX_1, SIP_TCP_SRV_PREFIX_2, ..., SIP_TCP_SRV_PREFIX_6
Value Format	String
Description	Specifies a prefix to add to the domain name when performing a DNS SRV lookup using TCP. Note <ul style="list-style-type: none"> This setting is available only when "SIP_DNSSRV_ENA_n" is set to "Y".
Value Range	Max. 32 characters
Default Value	_sip._tcp.
Web User Interface Reference	SRV lookup Prefix for TCP (Page 93)

SIP_100REL_ENABLE_n

Parameter Name Example	SIP_100REL_ENABLE_1, SIP_100REL_ENABLE_2, ..., SIP_100REL_ENABLE_6
Value Format	Boolean
Description	Specifies whether to add the option tag 100rel to the "Supported" header of the INVITE message. For details, refer to RFC 3262.
Value Range	<ul style="list-style-type: none"> Y (Enable 100rel function) N (Disable 100rel function) Note <ul style="list-style-type: none"> If set to "Y", the Reliability of Provisional Responses function will be enabled. The option tag 100rel will be added to the "Supported" header of the INVITE message and to the "Require" header of the "1xx" provisional message. If set to "N", the option tag 100rel will not be used.
Default Value	N
Web User Interface Reference	Supports 100rel (RFC 3262) (Page 96)

SIP_INVITE_EXPIRE_n

Parameter Name Example	SIP_INVITE_EXPIRE_1, SIP_INVITE_EXPIRE_2, ..., SIP_INVITE_EXPIRE_6
-------------------------------	--

Value Format	Integer
Description	Specifies the period, in seconds, in which the INVITE message will expire. This value is set in the "Expires" header of the INVITE request.
Value Range	0, 60–65535 (0: Disable)
Default Value	0

SIP_18X_RTX_INTVL_n

Parameter Name Example	SIP_18X_RTX_INTVL_1, SIP_18X_RTX_INTVL_2, ..., SIP_18X_RTX_INTVL_6
Value Format	Integer
Description	Specifies the retransmission interval, in seconds, for "18x" responses.
Value Range	0, 1–600 (0: Disable)
Default Value	0

SIP_PRSNC_ADDR_n

Parameter Name Example	SIP_PRSNC_ADDR_1, SIP_PRSNC_ADDR_2, ..., SIP_PRSNC_ADDR_6
Value Format	String
Description	Specifies the IP address or FQDN of the SIP presence server.
Value Range	Max. 127 characters (IP address in dotted-decimal notation or FQDN)
Default Value	Empty string
Web User Interface Reference	Presence Server Address (Page 90)

SIP_PRSNC_PORT_n

Parameter Name Example	SIP_PRSNC_PORT_1, SIP_PRSNC_PORT_2, ..., SIP_PRSNC_PORT_6
Value Format	Integer
Description	Specifies the port number to use for communication with the SIP presence server.
Value Range	1–65535
Default Value	5060
Web User Interface Reference	Presence Server Port (Page 90)

SIP_2NDPRSNC_ADDR_n

Parameter Name Example	SIP_2NDPRSNC_ADDR_1, SIP_2NDPRSNC_ADDR_2, ..., SIP_2NDPRSNC_ADDR_6
Value Format	String
Description	Specifies the IP address of the secondary presence server. Note <ul style="list-style-type: none"> This setting is available only when "SIP_PR SNC_ADDR_n" is specified in IP address notation.
Value Range	IP address in dotted-decimal notation
Default Value	Empty string

SIP_2NDPRSNC_PORT_n

Parameter Name Example	SIP_2NDPRSNC_PORT_1, SIP_2NDPRSNC_PORT_2, ..., SIP_2NDPRSNC_PORT_6
Value Format	Integer
Description	Specifies the port number to use for communication with the secondary SIP presence server.
Value Range	1–65535
Default Value	5060

USE_DEL_REG_OPEN_n

Parameter Name Example	USE_DEL_REG_OPEN_1, USE_DEL_REG_OPEN_2, ..., USE_DEL_REG_OPEN_6
Value Format	Boolean
Description	Specifies whether to enable cancelation before registration when, for example, the unit is turned on.
Value Range	<ul style="list-style-type: none"> Y (Enable cancelation before registration) N (Disable cancelation before registration)
Default Value	N

USE_DEL_REG_CLOSE_n

Parameter Name Example	USE_DEL_REG_CLOSE_1, USE_DEL_REG_CLOSE_2, ..., USE_DEL_REG_CLOSE_6
Value Format	Boolean

Description	Specifies whether to enable the cancelation of registration before the SIP function shuts down when, for example, the configuration has changed.
Value Range	<ul style="list-style-type: none"> • Y (Enable registration cancelation before shutting down) • N (Disable registration cancelation before shutting down) <p>Note</p> <ul style="list-style-type: none"> • If set to "Y", registration cancelation is enabled. • If set to "N", registration cancelation is disabled even when the SIP stack is shutting down.
Default Value	N

PORT_PUNCH_INTVL_n

Parameter Name Example	PORT_PUNCH_INTVL_1, PORT_PUNCH_INTVL_2, ..., PORT_PUNCH_INTVL_6
Value Format	Integer
Description	Specifies the interval, in seconds, between transmissions of the Keep Alive packet to the unit in order to maintain the NAT binding information.
	<p>Note</p> <ul style="list-style-type: none"> • This setting is available only when "SIP_TRANSPORT_n" is set to "0" for UDP.
Value Range	0, 10–300 (0: Disable)
Default Value	0
Web User Interface Reference	Keep Alive Interval (Page 96)

SIP_ADD_RPORT_n

Parameter Name Example	SIP_ADD_RPORT_1, SIP_ADD_RPORT_2, ..., SIP_ADD_RPORT_6
Value Format	Boolean
Description	Selects whether to add the "rport" parameter to the top Via header field value of requests generated. For details, refer to RFC 3581.
Value Range	<ul style="list-style-type: none"> • Y (Add Rport [RFC 3581]) • N (Do not add Rport [RFC 3581])
Default Value	N
Web User Interface Reference	Supports Rport (RFC 3581) (Page 97)

SIP_REQURI_PORT_n

Parameter Name Example	SIP_REQURI_PORT_1, SIP_REQURI_PORT_2, ..., SIP_REQURI_PORT_6
-------------------------------	--

Value Format	Boolean
Description	Specifies whether to add the port parameter to the Request-Line in the initial SIP request.
Value Range	<ul style="list-style-type: none"> • y (Add the port parameter) • n (Do not add the port parameter) <p>Note</p> <ul style="list-style-type: none"> • Request URI in REGISTER example: <ul style="list-style-type: none"> – If set to "y", the port parameter is added to the Request-Line, as follows: Request-Line: REGISTER sip:192.168.0.10:5060 SIP/2.0 – If set to "n", the port parameter is not added to the Request-Line, as follows: Request-Line: REGISTER sip:192.168.0.10 SIP/2.0
Default Value	y

SIP_SUBS_EXPIRE_n

Parameter Name Example	SIP_SUBS_EXPIRE_1, SIP_SUBS_EXPIRE_2, ..., SIP_SUBS_EXPIRE_6
Value Format	Integer
Description	Specifies the length of time, in seconds, that the subscription remains valid. This value is set in the "Expires" header of the SUBSCRIBE request.
Value Range	1–4294967295
Default Value	3600

SUB_RTX_INTVL_n

Parameter Name Example	SUB_RTX_INTVL_1, SUB_RTX_INTVL_2, ..., SUB_RTX_INTVL_6
Value Format	Integer
Description	<p>Specifies the interval, in seconds, between transmissions of SUBSCRIBE requests when a subscription results in failure (server no reply or error reply).</p> <p>Note</p> <ul style="list-style-type: none"> • Transmissions will not be sent when the "403 Forbidden" error occurred.
Value Range	10–86400
Default Value	10

REG_RTX_INTVL_n

Parameter Name Example	REG_RTX_INTVL_1, REG_RTX_INTVL_2, ..., REG_RTX_INTVL_6
Value Format	Integer
Description	Specifies the interval, in seconds, between transmissions of the REGISTER request when a registration results in failure (server no reply or error reply). Note <ul style="list-style-type: none"> • Transmissions will not be sent when the "403 Forbidden" error occurred.
Value Range	10–86400
Default Value	10

SIP_P_PREFERRED_ID_n

Parameter Name Example	SIP_P_PREFERRED_ID_1, SIP_P_PREFERRED_ID_2, ..., SIP_P_PREFERRED_ID_6
Value Format	Boolean
Description	Specifies whether to add the "P-Preferred-Identity" header to SIP messages.
Value Range	<ul style="list-style-type: none"> • Y (Add the "P-Preferred-Identity" header) • N (Do not add the "P-Preferred-Identity" header)
Default Value	N

SIP_PRIVACY_n

Parameter Name Example	SIP_PRIVACY_1, SIP_PRIVACY_2, ..., SIP_PRIVACY_6
Value Format	Boolean
Description	Specifies whether to add the "Privacy" header to SIP messages.
Value Range	<ul style="list-style-type: none"> • Y (Add the "Privacy" header) • N (Do not add the "Privacy" header)
Default Value	N

ADD_USER_PHONE_n

Parameter Name Example	ADD_USER_PHONE_1, ADD_USER_PHONE_2, ..., ADD_USER_PHONE_6
Value Format	Boolean
Description	Specifies whether to add "user=phone" to the SIP URI in SIP messages.

Value Range	<ul style="list-style-type: none"> • Y (Add "user=phone") • N (Do not add "user=phone") <p>Note</p> <ul style="list-style-type: none"> • SIP URI example: <ul style="list-style-type: none"> – "sip:1111@tokyo.example.com;user=phone", when set to "Y" – "sip:1111@tokyo.example.com", when set to "N"
Default Value	N

SDP_USER_ID_n

Parameter Name Example	SDP_USER_ID_1, SDP_USER_ID_2, ..., SDP_USER_ID_6
Value Format	String
Description	Specifies the user ID used in the "o=" line field of SDP.
Value Range	Max. 32 characters (except ", &, ', :, <, >, and space)
Default Value	–

SUB_INTERVAL_RATE_n

Parameter Name Example	SUB_INTERVAL_RATE_1, SUB_INTERVAL_RATE_2, ..., SUB_INTERVAL_RATE_6
Value Format	Integer
Description	Specifies the percentage of the "expires" value after which to refresh subscriptions by sending a new SUBSCRIBE message in the same dialog.
Value Range	1–100
Default Value	90

SIP_OUTPROXY_ADDR_n

Parameter Name Example	SIP_OUTPROXY_ADDR_1, SIP_OUTPROXY_ADDR_2, ..., SIP_OUTPROXY_ADDR_6
Value Format	String
Description	Specifies the IP address or FQDN of the SIP outbound proxy server.
Value Range	Max. 127 characters (IP address in dotted-decimal notation or FQDN)
Default Value	Empty string
Web User Interface Reference	Outbound Proxy Server Address (Page 91)

SIP_OUTPROXY_PORT_n

Parameter Name Example	SIP_OUTPROXY_PORT_1, SIP_OUTPROXY_PORT_2, ..., SIP_OUTPROXY_PORT_6
Value Format	Integer
Description	Specifies the port number to use for communication with the SIP outbound proxy server.
Value Range	1–65535
Default Value	5060
Web User Interface Reference	Outbound Proxy Server Port (Page 91)

SIP_TRANSPORT_n

Parameter Name Example	SIP_TRANSPORT_1, SIP_TRANSPORT_2, ..., SIP_TRANSPORT_6
Value Format	Integer
Description	Specifies which transport layer protocol to use for sending SIP packets.
Value Range	<ul style="list-style-type: none"> • 0 (UDP) • 1 (TCP)
Default Value	0
Web User Interface Reference	Transport Protocol (Page 93)

SIP_ANM_DISPNAME_n

Parameter Name Example	SIP_ANM_DISPNAME_1, SIP_ANM_DISPNAME_2, ..., SIP_ANM_DISPNAME_6
Value Format	Integer
Description	Specifies the text string to set as the display name in the "From" header when making anonymous calls.
Value Range	<ul style="list-style-type: none"> • 0 (Use normal display name) • 1 (Use "Anonymous" for display name) • 2 (Do not send a display name)
Default Value	1

SIP_ANM_USERNAME_n

Parameter Name Example	SIP_ANM_USERNAME_1, SIP_ANM_USERNAME_2, ..., SIP_ANM_USERNAME_6
Value Format	Integer
Description	Specifies the text string to set as the user name in the "From" header when making anonymous calls.

Value Range	<ul style="list-style-type: none"> • 0 (Use normal user name) • 1 (Use "anonymous" for user name) • 2 (Do not send a user name)
Default Value	0

SIP_ANM_HOSTNAME_n

Parameter Name Example	SIP_ANM_HOSTNAME_1, SIP_ANM_HOSTNAME_2, ..., SIP_ANM_HOSTNAME_6
Value Format	Boolean
Description	Specifies whether to set an anonymous host name in the "From" header when making anonymous calls.
Value Range	<ul style="list-style-type: none"> • Y (Use "anonymous.invalid" for host name) • N (Use normal host name)
Default Value	N

SIP_DETECT_SSAF_n

Parameter Name Example	SIP_DETECT_SSAF_1, SIP_DETECT_SSAF_2, ..., SIP_DETECT_SSAF_6
Value Format	Boolean
Description	Specifies whether to enable SSAF for the SIP servers (registrar server, proxy server, and presence server).
Value Range	<ul style="list-style-type: none"> • Y (Enable SSAF) • N (Disable SSAF) <p>Note</p> <ul style="list-style-type: none"> • If set to "Y", the unit receives SIP messages only from the source addresses stored in the SIP servers (registrar server, proxy server, and presence server), and not from other addresses. However, if "SIP_OUTPROXY_ADDR_n" in 5.8.2 SIP Settings is specified, the unit also receives SIP messages from the source address stored in the SIP outbound proxy server.
Default Value	N
Web User Interface Reference	Enable SSAF (SIP Source Address Filter) (Page 97)

SIP_RCV_DET_HEADER_n

Parameter Name Example	SIP_RCV_DET_HEADER_1, SIP_RCV_DET_HEADER_2, ..., SIP_RCV_DET_HEADER_6
Value Format	Boolean

Description	Specifies whether to check the username part of the SIP URI in the "To" header when receiving the INVITE message with an incorrect target SIP URI.
Value Range	<ul style="list-style-type: none"> • Y (Enable username check) • N (Disable username check) <p>Note</p> <ul style="list-style-type: none"> • If set to "Y", the unit will return an error reply when it receives the INVITE message with an incorrect target SIP URI. • If set to "N", the unit will not check the username part of the SIP URI in the "To" header.
Default Value	N

SIP_CONTACT_ON_ACK_n

Parameter Name Example	SIP_CONTACT_ON_ACK_1, SIP_CONTACT_ON_ACK_2, ..., SIP_CONTACT_ON_ACK_6
Value Format	Boolean
Description	Specifies whether to add the "Contact" header to SIP ACK message.
Value Range	<ul style="list-style-type: none"> • Y (Add the "Contact" header) • N (Do not add the "Contact" header)
Default Value	N

SIP_TIMER_B_n

Parameter Name Example	SIP_TIMER_B_1, SIP_TIMER_B_2, ..., SIP_TIMER_B_6
Value Format	Integer
Description	Specifies the value of SIP timer B (INVITE transaction timeout timer), in milliseconds. For details, refer to RFC 3261.
Value Range	250–64000
Default Value	32000
Web User Interface Reference	Timer B (Page 94)

SIP_TIMER_D_n

Parameter Name Example	SIP_TIMER_D_1, SIP_TIMER_D_2, ..., SIP_TIMER_D_6
Value Format	Integer
Description	Specifies the value of SIP timer D (wait time for answer resending), in milliseconds. For details, refer to RFC 3261.
Value Range	0, 250–64000

Default Value	5000
Web User Interface Reference	Timer D (Page 95)

SIP_TIMER_F_n

Parameter Name Example	SIP_TIMER_F_1, SIP_TIMER_F_2, ..., SIP_TIMER_F_6
Value Format	Integer
Description	Specifies the value of SIP timer F (non-INVITE transaction timeout timer), in milliseconds. For details, refer to RFC 3261.
Value Range	250–64000
Default Value	32000
Web User Interface Reference	Timer F (Page 95)

SIP_TIMER_H_n

Parameter Name Example	SIP_TIMER_H_1, SIP_TIMER_H_2, ..., SIP_TIMER_H_6
Value Format	Integer
Description	Specifies the value of SIP timer H (wait time for ACK reception), in milliseconds. For details, refer to RFC 3261.
Value Range	250–64000
Default Value	32000
Web User Interface Reference	Timer H (Page 95)

SIP_TIMER_J_n

Parameter Name Example	SIP_TIMER_J_1, SIP_TIMER_J_2, ..., SIP_TIMER_J_6
Value Format	Integer
Description	Specifies the value of SIP timer J (wait time for non-INVITE request resending), in milliseconds. For details, refer to RFC 3261.
Value Range	0, 250–64000
Default Value	5000
Web User Interface Reference	Timer J (Page 95)

ADD_TRANSPORT_UDP_n

Parameter Name Example	ADD_TRANSPORT_UDP_1, ADD_TRANSPORT_UDP_2, ..., ADD_TRANSPORT_UDP_6
Value Format	Boolean

Description	Specifies whether to add the attribute "transport=udp" to the SIP header URI.
Value Range	<ul style="list-style-type: none"> • Y (Add Transport UDP) • N (Do not add Transport UDP)
Default Value	N

ADD_EXPIRES_HEADER_n

Parameter Name Example	ADD_EXPIRES_HEADER_1, ADD_EXPIRES_HEADER_2, ..., ADD_EXPIRES_HEADER_6
Value Format	Boolean
Description	Specifies whether to add an "Expires" header to REGISTER (adds an "expires" parameter to the "Contact" header).
Value Range	<ul style="list-style-type: none"> • Y (Add Expires Header) • N (Do not add Expires Header)
Default Value	Y

SIP_HOLD_HOLDRECEIVE_n

Parameter Name Example	SIP_HOLD_HOLDRECEIVE_1, SIP_HOLD_HOLDRECEIVE_2, ..., SIP_HOLD_HOLDRECEIVE_6
Value Format	Boolean
Description	Specifies whether to allow re-INVITE for calls on hold.
Value Range	<ul style="list-style-type: none"> • Y (Enable SIP Hold Receive) • N (Disable SIP Hold Receive)
Default Value	Y

SIP_ADD_DIVERSION_n

Parameter Name Example	SIP_ADD_DIVERSION_1, SIP_ADD_DIVERSION_2, ..., SIP_ADD_DIVERSION_6
Value Format	Integer
Description	Specifies whether to add Diversion header information.
Value Range	0–2 – 0: Do not add Diversion header information – 1: Use own diversion information only for the Diversion header – 2: Add diversion information to existing Diversion header
Default Value	1

SIP_RESPONSE_CODE_DND

Value Format	Integer
Description	Selects the response code when a call is received in Do Not Disturb mode.
Value Range	400–699
Default Value	403

SIP_RESPONSE_CODE_CALL_REJECT

Value Format	Integer
Description	Selects the response code when a call is rejected.
Value Range	400–699
Default Value	603

Section 6

Useful Telephone Functions

This section explains some of the main telephone features.

6.1 Registering One-touch Buttons and BLF Buttons

You can register One-touch buttons and BLF (extension status display) buttons by setting the configuration file as shown below (→ see **5.6.4 Flexible Button Settings**).

For more details about flexible buttons, refer to the Operating Instructions on the Panasonic Web site (→ see **Introduction**).

Registering a One-touch button:

- Set "**FLEX_BUTTON_FACILITY_ACTx**" to "**X_PANASONIC_IPTTEL_ONETOUCH**".
- Specify a 1–32 digit number in "**FLEX_BUTTON_FACILITY_ARGx**".

Registering a BLF button:

- Set "**FLEX_BUTTON_FACILITY_ACTx**" to "**X_PANASONIC_IPTTEL_CONTACT**".
- Specify a 1–32 digit number in "**FLEX_BUTTON_FACILITY_ARGx**".

6.2 Setting the Feature Number to Access Voice Mail

You can set the feature number to access voice mail by setting the configuration file as shown below.

- Specify the telephone number to access the voice mail server in "**VM_NUMBER_n**" (→ see **5.8.1 Call Control Settings**).

6.3 Registering Flexible Buttons

You can assign certain features to flexible buttons by specifying the flexible button configuration file parameters.

- For details about flexible button configuration file parameters, see **5.6.4 Flexible Button Settings**.

6.4 Customizing the Phone

You can set the wallpaper of the Home screen, the wallpaper of the Phone screen, and the logo of the Phone screen via configuration file programming, using the following settings.

- **WALLPAPER_URI_HOME** (→ see Page 174)
- **WALLPAPER_URI_PHONE** (→ see Page 174)
- **LOGO_URI_PHONE** (→ see Page 175)

Also, you can set whether the user can change the wallpaper of the Home screen and the wallpaper of the Phone screen via phone user interface programming.

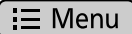
1. Press  **Menu** on the Home screen, and then tap **[Settings]**.
2. Tap **[Administration]**, enter the administrator password, and then tap **[OK]**.
3. Tap **[Customize]**.
4. Specify **[Specify through configuration file]**, **[Forbid change of the home screen wallpaper]**, or **[Forbid change of the phone screen wallpaper]**.

Note

- When a value has been specified (anything other than an empty string) for "**WALLPAPER_URI_HOME**" or "**WALLPAPER_URI_PHONE**" through configuration file programming, and **[Specify through configuration file]** is selected, users cannot change the wallpaper of that screen.

- If **[Specify through configuration file]** is selected, **[Forbid change of the home screen wallpaper]** and **[Forbid change of the phone screen wallpaper]** will be grayed out.
- For details about the administrator password, see **3.1.2 Phone User Interface Administrator Menu**.

6.5 Adding Applications

You can install third-party applications and manage (display application information, uninstall, etc.) them on the phone. Applications must be installed via the SD card.

IMPORTANT

- Sufficiently check the source and operations of all applications before installing. You may not be able to install or operate some applications, depending on the application. Also, be aware that applications may contain viruses or may be able to access location data or personal data etc. stored on the unit. This data may then be leaked onto the Internet and used improperly.
- Panasonic cannot accept any responsibility if an installed application causes performance problems or losses of any kind to the user or a third party.

Prepare an application

You can install applications from the unit's Web browser or an SD card. When using an SD card, follow the procedure below before installing.

Notice

- Format the SD card before use. For details about formatting, refer to the Operating Instructions on the Panasonic Web site (→ see **Introduction**).

1. Prepare an SD card.
For details about supported SD cards, refer to the Panasonic Web site (→ see **Introduction**).
2. Save the application data in the root directory of the SD card.

To install the application

1. Press **[Menu]** on the Home screen, and then tap **[Settings]**.
2. Tap **[Administration]**, enter the administrator password, and then tap **[OK]**.
3. Tap **[Applications]**.
4. Tap **[Install applications]**.
5. Select the installation method from **[SD card]** or **[Browser]**.
6. Select the application to install.
7. Tap **[Install]**.
8. Tap **[OK]**.

Note

- For details about the administrator password, see **3.1.2 Phone User Interface Administrator Menu**.

To manage the application

1. Press **[Menu]** on the Home screen, and then tap **[Settings]**.
2. Tap **[Administration]**, enter the administrator password, and then tap **[OK]**.
3. Tap **[Applications]**.
4. Tap **[Manage applications]**.
5. Select the application.
6. Select the operation and tap **[OK]**.

Note

- For details about the administrator password, see **3.1.2 Phone User Interface Administrator Menu**.

6.6 Dial Plan

The dial plan settings control how numbers dialed by the user are transmitted over the network. Dial plan settings can be configured on a per-line basis. These settings can be programmed either through the Web user interface (→ see **4.7.2.2 Dial Plan**) or by configuration file programming (→ see **5.8.1 Call Control Settings**).

[Dial Plan Flowchart]

When a user dials a single digit on a unit, the following sequence of events begins.

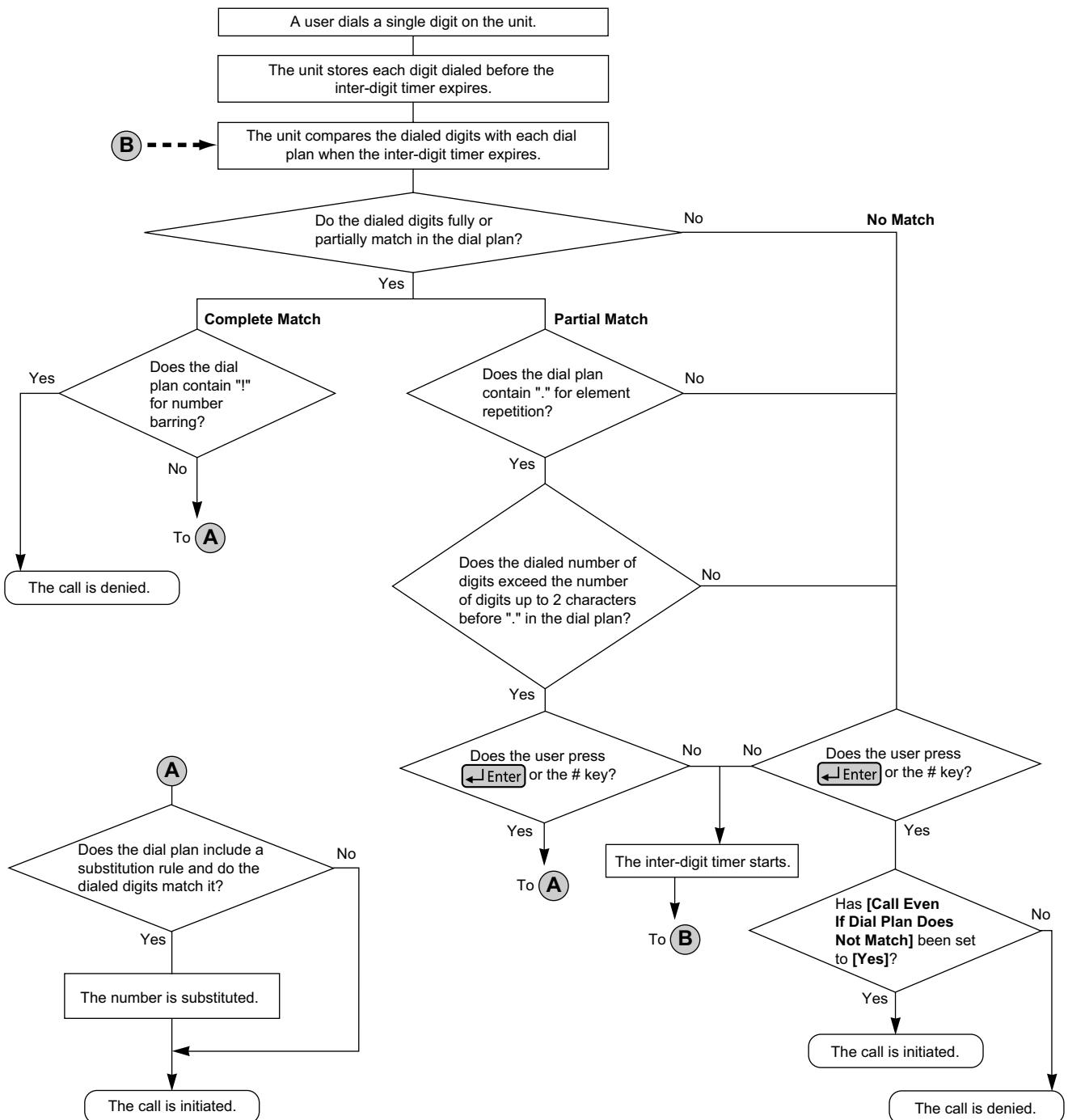

6.6.1 Dial Plan Settings

To set Dial Plan

1. In the Web user interface, click the **[Telephone]** tab, and then click **[Call Control [Line 1]–[Line 6]]**.
2. In **[Dial Plan]**, enter the desired dial format.
The dial plan settings can be configured for each line separately.

Section 6 Useful Telephone Functions

For details about available characters for the dial format, see **Available Values for the Dial Plan Field** in this section.

3. Select **[Yes]** or **[No]** for **[Call Even If Dial Plan Does Not Match]**.

- If you select **[Yes]**, the call will be made even if the user dials a phone number that does not match the dial format in **[Dial Plan]**.
- If you select **[No]**, the call will be made only if the user dials a phone number that matches the dial format in **[Dial Plan]**.

Note

- For details about configuring these settings by configuration file programming, see "DIAL_PLAN_n" and "DIAL_PLAN_NOT_MATCH_ENABLE_n" in **5.8.1 Call Control Settings**.

Available Values for the Dial Plan Field

The following table explains which characters you can use in the dial format, and what the characters mean.

Element	Available Value	Description
String	0–9, [, -,], <, :, >, *, #, !, S, s, T, t, X, x, ., , +	You can enter dial plan descriptions using a combination of the characters listed as available values.
Digit	0–9, *, #, +	Example: "123" If the dialed phone number is "123", the call is made immediately.
Wildcard	X, x	Example: "12xxxxx" If the dialed phone number is "12" followed by any 5-digit number, the call is made immediately.
Range	[]	Example: "[123]" If the dialed phone number is either one of "1", "2", or "3", the call is made immediately.
Subrange	-	Example: "[1-5]" If the dialed phone number is "1", "2", "3", "4", or "5", the call is made immediately. <ul style="list-style-type: none"> • A subrange is only valid for single-digit numbers. For example, "[4-9]" is valid, but "[12-21]" is invalid.
Repeat	.	Example: "1." If the dialed phone number is "1" followed by zero or more "1"s (e.g., "11", "111"), the call is made.
Substitution	<(before):(after)>	Example: "<101:9999>" If the dialed phone number is "101", "101" is replaced by "9999", and then the call is made immediately.
Timer	S, s (second)	Example: "1x.S2" If the dialed phone number begins with "1", the call is made after a lapse of 2 seconds. <ul style="list-style-type: none"> • The number (0–9) followed by "S" or "s" shows the duration in seconds until the call is made.

Element	Available Value	Description
Macro Timer	T, t	Example: "1x.T" If the dialed phone number begins with "1", the call is made after a lapse of "T" seconds. <ul style="list-style-type: none"> The value of "T" or "t" can be configured through the Web user interface (→ see [Timer for Dial Plan] in 4.7.1.1 Call Control).
Reject	!	Example: "123xxx!" If the dialed phone number is "123" followed by 3 digits, the call is not made.
Alternation		Example: "1xxxx 2xxx" If the dialed phone number is "1" followed by 4 digits, or "2" followed by 3 digits, the call is made immediately. You can use this element to specify multiple numbers.

Note

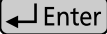
- You can enter up to 500 characters in [Dial Plan].
- You can assign up to 40 dial plans separated by "|" in [Dial Plan].
- You can assign up to 32 digits per dial plan in [Dial Plan].
- After the user completes dialing, the unit immediately sends all the dialed digits if [Call Even If Dial Plan Does Not Match] is set to [Yes] in the Web user interface or if "DIAL_PLAN_NOT_MATCH_ENABLE_n" is set to "N" in a configuration file. The unit recognizes the end of dialing as follows:
 - The inter-digit timer expires (→ see [Inter-digit Timeout] in 4.7.1.1 Call Control in the Web user interface or "INTDIGIT_TIM" in 5.6.1 Call Control Settings in the configuration file).
 - The user presses  or the # key.
 - The call is initiated after going off-hook (pre-dial).

Dial Plan Example

The following example shows dial plans containing character sequences separated by "|".
Example: "[2346789]11|01[2-9]x.[2-9]xxxxxxxxx"

Complete Match:

Example: "[2346789]11|01[2-9]x.[2-9]xxxxxxxxx"

- If the dialed phone number is "211", "911" and so on, the call is made immediately.

Example: "[2346789]11|01[2-9]x.[2-9]xxxxxxxxx"

- If the dialed phone number is "2123456789", "5987654321" and so on, the call is made immediately.

Partial Match (when the dial plan contains "."):

Example: "[2346789]11|01[2-9]x.[2-9]xxxxxxxxx"

- If the dialed phone number is "01254", "012556" and so on, the call is made after the inter-digit timer expires.

Partial Match (when the dial plan does not contain "."):

Example: "[2346789]11|01[2-9]x.[2-9]xxxxxxxxx"

- If the dialed phone number is "21", "91" and so on when [Call Even If Dial Plan Does Not Match] is set to [Yes], the call is made after the inter-digit timer expires.

Section 6 Useful Telephone Functions

- If the dialed phone number is "21", "91" and so on when **[Call Even If Dial Plan Does Not Match]** is set to **[No]**, the call is denied after the inter-digit timer expires.

Example: "[2346789]11|01[2-9]x.|[2-9]xxxxxxxx"

- If the dialed phone number is "21234567", "598765432" and so on when **[Call Even If Dial Plan Does Not Match]** is set to **[Yes]**, the call is made after the inter-digit timer expires.
- If the dialed phone number is "21234567", "598765432" and so on when **[Call Even If Dial Plan Does Not Match]** is set to **[No]**, the call is denied after the inter-digit timer expires.

No Match:

Example: "[2346789]11|01[2-9]x.|[2-9]xxxxxxxx"

- If the dialed phone number is "0011", "1011" and so on when **[Call Even If Dial Plan Does Not Match]** is set to **[Yes]**, the call is made after the inter-digit timer expires.
- If the dialed phone number is "0011", "1011" and so on when **[Call Even If Dial Plan Does Not Match]** is set to **[No]**, the call is denied.

Section 7

Firmware Update

This section explains how to update the firmware of the unit.

7.1 General Information on Firmware Update

You can update the unit's firmware to improve the unit's operation. You can configure the unit so that it automatically downloads the new firmware file from a specified location. The firmware update will be executed when the unit is restarted.

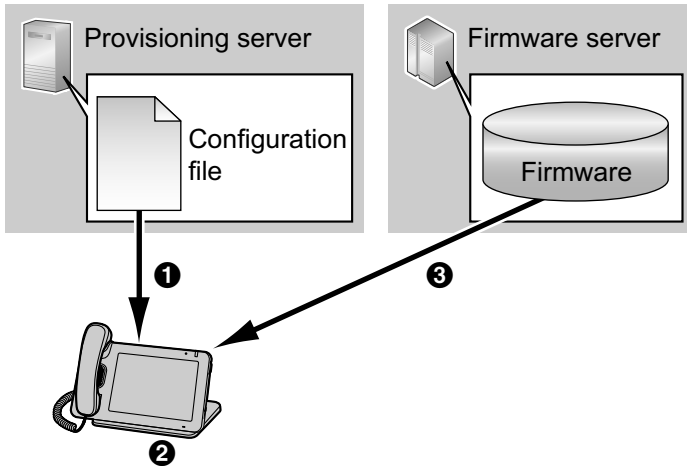

- 1 Download configuration file
- 2 Check for update by comparing the unit's firmware version with the downloaded configuration file's version
- 3 Firmware download and update

Note

- No special server is necessary for the firmware update. You can use an HTTP or FTP server as the firmware server by simply setting its URL.
- You cannot use a TFTP server as the firmware server.

7.2 Firmware Update Settings

Firmware updates are provided by the manufacturer when necessary.

The firmware update will be executed by setting the corresponding parameters using configuration file programming (→ see **5.4.4 Firmware Update Settings**) or Web user interface programming (→ see **4.8.1 Firmware Maintenance**). The following shows the parameters and the setting procedures:

Firmware Update Enable/Disable

- In a configuration file, add the line, `FIRM_UPGRADE_ENABLE="Y"`.
- In the Web user interface, click the **[Maintenance]** tab, click **[Firmware Maintenance]**, and then select **[Yes]** for **[Enable Firmware Update]**.

Firmware Version Number

- In a configuration file, specify the new version number in "`FIRM_VERSION`".

Firmware Server URL

- In a configuration file, specify the URL in "`FIRM_FILE_PATH`".
- In the Web user interface, click the **[Maintenance]** tab, click **[Firmware Maintenance]**, and then enter the URL in **[Firmware File URL]**.

Configuration Parameter Example

By setting the parameters as shown in the following example, the unit will automatically download the firmware file from the specified URL, "http://firm.example.com/firm/UT670_01.050.bin", and perform the update operation if the currently used firmware version is older than 01.050.

Example

```
FIRM_UPGRADE_ENABLE="Y"
```

```
FIRM_VERSION="01.050"
```

```
FIRM_FILE_PATH="http://firm.example.com/firm/UT670_01.050.bin"
```

7.3 Executing Firmware Update

After configuring the firmware update settings in the configuration file, the firmware will be updated when the configuration file is downloaded. The firmware update procedure is detailed below.

The firmware update process

Step 1

The unit downloads a configuration file from the provisioning server.

- For details about setting the timing of when configuration files are downloaded, see [2.4.3.4 Downloading Configuration Files](#).

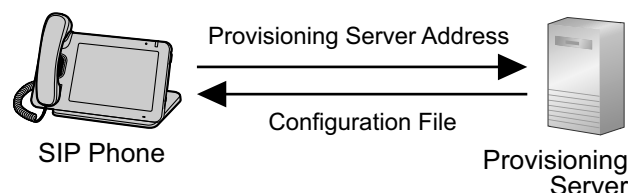

Step 2

The unit compares the version number of the firmware in the configuration file to the unit's current firmware version.

(In this example, the unit is using version 01.000 and the configuration file specifies version 01.050.)

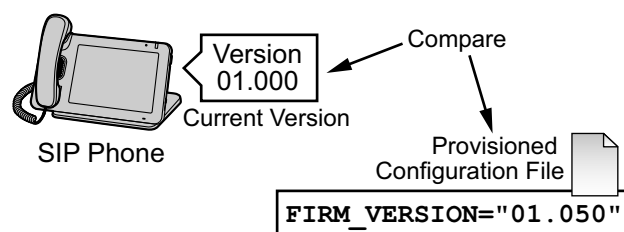

Step 3

When a newer firmware version is specified in the configuration file, the unit is restarted. Then, the unit will download the firmware from the address specified under "FIRM_FILE_PATH" in the configuration file.

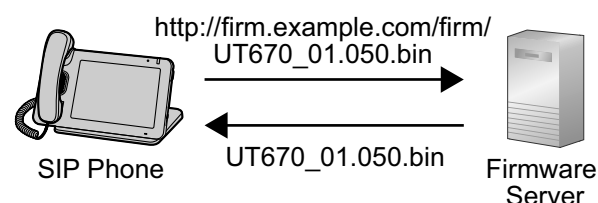

Step 4

Once the newer firmware is downloaded, it is applied to the unit and the unit automatically restarts.

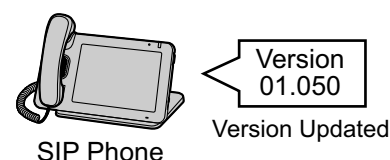

7.4 Firmware Update Using the SD Card

When a firmware update is provided by the manufacturer, you can update manually via the unit.

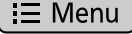
1. Download the latest firmware from the Panasonic Web site (→ see **Introduction**).
2. Save the downloaded firmware in the root directory of the SD card.
3. Insert the SD card into the unit.
4. Press  **Menu** on the Home screen, and then tap **[Settings]**.
5. Tap **[Administration]**, enter the administrator password, and then tap **[OK]**.
6. Tap **[Update Firmware]**.
7. Select the downloaded firmware.
8. Tap **[Update]**.

Notice

- Unmount the SD card before removing it from the unit. For details about unmounting the SD card, refer to the Operating Instructions on the Panasonic Web site (→ see **Introduction**).

Note

- When the update is complete, the unit will automatically restart.
- The update procedure may change. The latest update procedure is provided on the Panasonic Web site (→ see **Introduction**).
- For details about the administrator password, see **3.1.2 Phone User Interface Administrator Menu**.

Section 8

Backup and Restore

This section explains how to back up data from and restore data to the unit.

8.1 Backup and Restore

You can back up user data (including Web programming settings) to an SD card, or restore data from the SD card.

Only the built-in applications are stored on the SD card. Third-party applications cannot be backed up.

The data is saved onto the SD card as follows:

Folder name	/sdcard/kx-ut670
Backup data file name	YYYYMMDDHHMM(UTC)_backup.dat Note <ul style="list-style-type: none"> The time stamp of the backup data file will be in UTC, regardless of the time zone setting.
Backup information file name	bkinfo.dat

Notice

- It is the user's responsibility to ensure that the backup data saved on the SD card is kept secure.

To Back Up Data to an SD Card

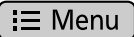
- Press  **Menu** on the Home screen, and then tap **[Settings]**.
- Tap **[Administration]**, enter the administrator password, and then tap **[OK]**.
- Tap **[Backup and Restore]**.
- Tap **[Backup data to SD card]**.
- On the backup confirmation window, tap **[OK]**.
- Enter the new password for backup, and enter it again for confirmation.
- When the completed message is displayed, tap **[OK]**.

Note

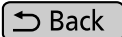
- Backup can be performed only when the unit is idle. Also, the unit cannot receive calls during the backup.
- Only 1 backup file can be stored on the SD card. If the SD card contains a backup file, the existing file is overwritten.
- The password must consist of 8 or more ASCII characters (case-sensitive) (→ see **Entering Characters** in 4.2.4 **Accessing the Web User Interface**). Backup can also be performed without requiring a password.
- If you press  **Back** during the backup, the backup will be canceled.

To Restore Data from the SD Card

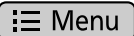
- Press  **Menu** on the Home screen, and then tap **[Settings]**.
- Tap **[Administration]**, enter the administrator password, and then tap **[OK]**.
- Tap **[Backup and Restore]**.
- Tap **[Restore data from SD card]**.
- Enter the password that was set when the data was stored.
- On the restore confirmation window, tap **[OK]**.

Note

- After the restoring is completed, the unit will restart automatically.
- You cannot operate the unit during the restore.
- If the unit's firmware version changes between backup and restore, the data cannot be restored.
- If restoring fails, the unit enters recovery mode. After recovery, the unit will restart automatically.

Section 9

Resetting the Unit

This section explains how to reset the unit.

9.1 Resetting to Factory Default and Clearing Data/Settings

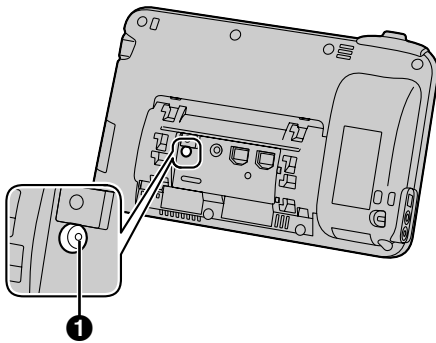

When you reset the unit, all settings are returned their factory default status and all data is erased. You can reset the unit in the following 2 ways.

- **Clear data and settings**
All unit settings and the settings and registered data of applications are erased. However, applications are not erased.
 - **Reset to factory default**
All data is erased. Applications, apart from pre-installed applications, are also erased.
1. After starting the unit, press and hold the RESET button (❶) with a pointy object until the screen is cleared.

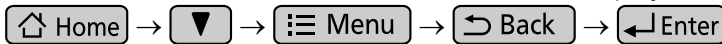

2. After the unit is restarted and ****Reset Menu**** is displayed, tap the key sheet in the following order:

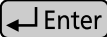

3. Tap  or  to select the resetting type, and then tap .

Note

- For details about the key sheet, refer to the Operating Instructions on the Panasonic Web site (→ see **Introduction**).
- Data stored on the SD card is not erased.
- If you tap **[Cancel]**, the unit will start-up and the Home screen is displayed.
- When the reset is complete, the unit will automatically restart.

9.2 Resetting the Settings Made through the Web User Interface (Reset Web Settings)

Performing Reset Web Settings from the Web user interface (→ see **4.8.3 Reset to Defaults**) resets the settings made through the Web user interface to their default values.

When you use this feature, the unit will return to the status just after performing the most recent provisioning or pre-provisioning.

Notice

- After performing Reset Web Settings, the unit will restart automatically. To avoid problems, it is recommended that you save your settings before performing Reset Web Settings.

Note

- The settings configured through the phone user interface only will not be reset. However, settings that can be configured through both the phone user interface and Web user interface will be reset.

Section 10

Troubleshooting

This section provides information about troubleshooting.

10.1 Troubleshooting

If a problem occurs, refer to this section. Before inspection, confirm that the unit is corrected properly and that power is being supplied through the Ethernet cable. If using an AC adaptor, confirm that power is being supplied through the connected outlet.

If the problem persists, disconnect the plug or Ethernet cable from the unit, then connect it again.

General Use

Problem	Cause/Solution
I cannot hear a dial tone.	<ul style="list-style-type: none"> • Confirm that the Ethernet cable is properly connected. For details, refer to the Operating Instructions on the Panasonic Web site (→ see Introduction). • Network settings may not be correct. • Many installation issues can be resolved by resetting all the equipment. First, shut down your modem, router, hub, unit, and PC. Then turn the devices back on, one at a time, in this order: modem, router, hub, unit, PC. • If you cannot access Internet Web pages using your PC, check to see if your phone system is having connection issues in your area. • Check the VoIP status in [Phone status] on the unit's notification screen, or tap [Settings] → [About phone] → [Status] and confirm that each line is registered properly. For details, refer to the Operating Instructions on the Panasonic Web site (→ see Introduction). • Check that the SIP server address, URLs of the configuration files, encryption key, and other required settings are correct. • For details about the settings, consult your network administrator or phone system dealer.
An error message is displayed.	<ul style="list-style-type: none"> • Check the unit's settings according to the error message.
Edited data is not saved.	<ul style="list-style-type: none"> • If you open another screen while editing data, the data may not be saved. For details, refer to the Operating Instructions on the Panasonic Web site (→ see Introduction).
The Phone screen is not displayed after starting up the unit.	<ul style="list-style-type: none"> • Web user interface settings or configuration file settings may not be correct. Reset the unit to initialize the settings (→ see 9.1 Resetting to Factory Default and Clearing Data/Settings), and then reconfigure the unit correctly. <p>Note</p> <ul style="list-style-type: none"> • If settings were not initialized after performing this procedure, consult your phone system dealer.

Making/Answering Calls, Intercom

Problem	Cause/Solution
The unit does not ring.	<ul style="list-style-type: none"> • The ringer volume is turned off. Adjust the ringer volume. For details about the operations, refer to the Operating Instructions on the Panasonic Web site (→ see Introduction). • Check the VoIP status in [Phone status] on the unit's notification screen, or tap [Settings] → [About phone] → [Status] and confirm that each line is registered properly. For details, refer to the Operating Instructions on the Panasonic Web site (→ see Introduction). • Check that the SIP server address, URLs of the configuration files, encryption key, and other required settings are correct. • Check the firewall and port forwarding settings on the router (→ see 1.1.4 Other Network Settings). • Check [Call Control] for each line in the [Telephone] tab in the Web user interface. <ul style="list-style-type: none"> – If [Do Not Disturb] is set to [Yes], the unit does not receive calls (→ see 4.7.2.3 Call Features). – If [Unconditional (Enable Call Forward)] is set to [Yes], the unit does not receive calls (→ see 4.7.2.4 Call Forward). – If [Block Anonymous Call] is set to [Yes], the unit does not receive anonymous calls (→ see 4.7.2.3 Call Features). • Check that [Do Not Disturb], [Enable Call Forward], and [Block Anonymous Call] are not controlled by your phone system. • For details about settings, consult your network administrator or phone system dealer.
I cannot make a call.	<ul style="list-style-type: none"> • Check the VoIP status in [Phone status] on the unit's notification screen, or tap [Settings] → [About phone] → [Status] and confirm that each line is registered properly. For details, refer to the Operating Instructions on the Panasonic Web site (→ see Introduction). • Check that the SIP server address, URLs of the configuration files, encryption key, and other required settings are correct. • Check the firewall and port forwarding settings on the router (→ see 1.1.4 Other Network Settings). • For details about settings, consult your network administrator or phone system dealer.

Password for Web User Interface Programming

Problem	Cause/Solution
I have lost the login password of the Web user interface for the Administrator or User account.	<ul style="list-style-type: none"> Reset the password from the unit. The passwords for both Administrator and User will be reset (→ see 3.1.1.2 Reset Web ID/Password). For security reasons, it is recommended that the passwords are set again immediately (→ see 4.5.2 Administrator Password or 4.5.3 Change User Password).

Time

Problem	Cause/Solution
The time is not correct.	<ul style="list-style-type: none"> Adjust the date and time of the unit. For details about the operations, refer to the Operating Instructions on the Panasonic Web site (→ see Introduction). Automatic time adjustment can be enabled by configuring the NTP synchronization and time zone settings in the unit's [Settings] menu. For details, refer to the Operating Instructions on the Panasonic Web site (→ see Introduction). If the time is still incorrect even after setting NTP synchronization, check the firewall and port forwarding settings on the router (→ see 1.1.4 Other Network Settings).

SD Cards

Problem	Cause/Solution
Thumbnails of images on the SD card are not displayed, or different images are displayed.	<ul style="list-style-type: none"> The SD card was not unmounted before it was removed from the unit. Unmount the SD card before removing it. Additionally, follow the procedure below to display the correct thumbnail images: <ol style="list-style-type: none"> Press  Menu on the Home screen, and then tap [Settings]. Tap [SD card & phone storage]. Tap [Clear cache]. Tap [Clear and reboot]. After the unit has rebooted the correct thumbnail images will be displayed.

USB Devices

Problem	Cause/Solution
Some keys on the USB keyboard do not work.	<ul style="list-style-type: none"> Check which keys can be used on the unit. For details, refer to the Operating Instructions on the Panasonic Web site (→ see Introduction).

Firmware Update

Problem	Cause/Solution
Firmware update using the SD card does not work.	<ul style="list-style-type: none"> Confirm that the firmware is saved in the root directory of the SD card. Firmware cannot be updated while on a call. End the current call.

Applications

Problem	Cause/Solution
I cannot install applications.	<ul style="list-style-type: none"> Confirm that the application you are installing is saved in the root directory of the SD card (→ see 6.5 Adding Applications). Confirm that the file extension of the application you are installing is ".apk".

Configuration File

Problem	Cause/Solution
I cannot set the configuration file.	<ul style="list-style-type: none"> When importing the configuration file using an SD card, confirm that the configuration file is saved in the root directory of the SD card (→ see 2.4.5 Loading Settings Using the SD card). The configuration file cannot be imported from the SD card while on a call. End the current call. Confirm that the file extension of the configuration file is ".cfg". Confirm that the configuration file is configured correctly (→ see 5.2.1 Configuration File Specifications for Plain Text Provisioning).

Checking the Status of the Unit

You can check the status of the unit by using Web user interface programming (→ see **4.3.2 Network Status** and **4.3.3 VoIP Status**) or by looking at system logs (→ see **5.4.3 Syslog Settings**) sent from the unit.

To check the setting status in the Web user interface

1. Click the **[Status]** tab, and then click **[Network Status]** to check the network settings.
2. Check the status displayed.
3. Click **[VoIP Status]** to check the VoIP settings.
4. Check the status displayed.

To send system logs to the syslog server

Set the following parameters to specify your PC (Windows, Linux® operating system, etc.) as the syslog server:

- **SYSLOG_ADDR**: Specifies the IP address or FQDN of the syslog server.
- **SYSLOG_PORT**: Specifies the port number of the syslog server.

Section 11

Open Source Software

Parts of this product use Open Source Software. Relevant conditions apply to this software. Panasonic cannot accept inquiries regarding the content of the following copyright and license information.

11.1 License Information

You can check the license information of open source software on the unit's screen.

To check the license information

1. Press  **Menu** on the Home screen, and then tap **[Settings]**.
2. Tap **[About phone]** and then select **[Legal information]**.
3. Tap **[Open source licenses]**.

Section 12

Appendix

12.1 Revision History

12.1.1 Software File Version 01.030

New Contents

- 2.4.1 Configuration File Programming Methods (Page 25)
- 2.4.4 XML Provisioning (Page 32)
- 4.6.4.1 Quality of Service (QoS)—RTCP Packet QoS (DSCP) (Page 100)
- 4.6.4.4 DTMF—DTMF Relay (Page 102)
- 4.7.1.1 Call Control—Conference Server URI (Page 106)
- 4.7.2.1 Call Control
 - Enable Shared Call (Page 110)
 - Synchronize Do Not Disturb and Call Forward (Page 110)
- 5.6.1 Call Control Settings
 - CONFERENCE_SERVER_URI (Page 160)
 - DDI_ICD_GROUP_DISPLAY (Page 165)
- 5.6.3 Telephone Settings
 - WALLPAPER_URI_HOME (Page 174)
 - WALLPAPER_URI_PHONE (Page 174)
 - LOGO_URI_PHONE (Page 175)
- 5.7.2 RTP Settings—DSCP_RTCP_n (Page 178)
- 5.7.3 Miscellaneous VoIP Settings—DTMF_RELAY_n (Page 183)
- 5.8.1 Call Control Settings
 - SHARED_CALL_ENABLE_n (Page 186)
 - FWD_DND_SYNCHRO_ENABLE_n (Page 186)
 - VOICE_MESSAGE_AVAILABLE (Page 188)
- 5.8.2 SIP Settings—USE_DEL_REG_CLOSE_n (Page 200)
- 6.4 Customizing the Phone (Page 212)
- Section 8 Backup and Restore (Page 223)

Changed Contents

- 3.1.1 Direct Commands (Page 48)
- 3.1.2 Phone User Interface Administrator Menu (Page 49)

- 5.2.1 Configuration File Specifications for Plain Text Provisioning (Page 135)
- 5.4.2 System Time Settings—TIME_ZONE_COUNTRY (Page 141)
- 10.1 Troubleshooting—SD Cards (Page 234)

12.1.2 Software File Version 01.070

New Contents

- 4.4.2.2 LLDP Settings
 - LLDP (Page 74)
 - LLDP-MED Interval timer (Page 74)
 - PC (VLAN ID) (Page 75)
 - PC (Priority) (Page 75)

Changed Contents

- 1.1.3 Basic Network Setup (Page 16)
- 2.4.4.2 XML Element/Attribute Configuration Parameter Table
 - X_P_IPTTEL_LLDP (Page 41)
- 4.1 Web User Interface Setting List
 - LLDP (Page 74)
- 4.4.2 Ethernet Port Settings (Page 73)
- 5.1 Configuration File Parameter List
 - Network Settings (Page 129)
- 5.5.1 Ethernet Port Settings
 - LLDP_ENABLE (Page 151)
 - LLDP_INTERVAL (Page 152)
 - LLDP_VLAN_ID_PC (Page 152)
 - LLDP_VLAN_PRI_PC (Page 152)

Index

Numerics

1–30 108

A

Access Level 52, 62
 Access Levels (IDs and Passwords) 61, 62
 Accessing the Web User Interface 63
 ADD_EXPIRES_HEADER_n 209
 ADD_TRANSPORT_UDP_n 208
 ADD_USER_PHONE_n 203
 Adding Applications 213
 ADMIN_ID 140
 ADMIN_PASS 140
 Administrator Password 83
 Applications, Adding 213
 Authentication ID 78, 92
 Authentication Password 78, 92
 AUTO_ANS_RING_TIM 163
 AUTO_CALL_HOLD 163
 Available Values for the Dial Plan Field 216

B

Backup and Restore 224
 Basic Network Settings 16, 69
 Basic Network Setup 16
 Before Accessing the Web User Interface 61
 BLF Buttons 212
 Block Anonymous Call 112
 Block Caller ID 112
 Busy (Enable Call Forward) 114
 Busy (Phone Number) 115
 Busy Tone 118
 BUSY_TONE_FRQ 168
 BUSY_TONE_GAIN 168
 BUSY_TONE_TIMING 168

C

Call Control 105, 109
 Call Control [Line 1]–[Line 6] 109
 Call Control Settings 129, 132, 159, 184, 216
 Call Even If Dial Plan Does Not Match 111
 Call Features 112
 Call Forward 113, 114, 115
 Call Hold 103, 183
 Call Rejection Phone Numbers 108
 Cancel Button 65
 CFG_CYCLIC 149
 CFG_CYCLIC_INTVL 150
 CFG_FILE_KEY_LENGTH 149
 CFG_FILE_KEY1 148
 CFG_FILE_KEY2 149
 CFG_FILE_KEY3 149
 CFG_MASTER_FILE_PATH 147
 CFG_PRODUCT_FILE_PATH 146
 CFG_RESYNC_FROM_SIP 151
 CFG_RESYNC_TIME 150
 CFG_ROOT_CERTIFICATE_PATH 156
 CFG_RTRY_INTVL 150
 CFG_STANDARD_FILE_PATH 145
 Change Administrator Password 84

Change User Password 85
 Channel 1–25 82
 Characters Available for String Values 137
 Checking the Status of the Unit 235
 CODEC Preferences 103
 Codec Settings 132, 176
 Codec Settings, Examples 138
 CODEC_ENABLEx_n 177
 CODEC_G711_REQ 176
 CODEC_G729_PARAM 177
 CODEC_PRIORITYx_n 177
 Conference Server URI 106
 CONFERENCE_SERVER_URI 160
 Configuration File 27
 Configuration File Examples 137
 Configuration File Parameter List 128
 Configuration File Parameters 136
 Configuration File Programming 24, 127
 Configuration File Programming Methods 25
 Configuration File Specifications for Plain Text Provisioning 135
 Configuration Files 135
 Confirm New Password 84, 86
 Connection Mode 67, 70
 Controls on the Window 64
 Country Calling Code 107
 COUNTRY_CALLING_CODE 161
 Current Password 84, 85
 CUSTOM_WEB_PAGE 159
 Customizing the Phone 212
 CW_ENABLE_n 187
 CW_TONE1_FRQ 171
 CW_TONE1_GAIN 171
 CW_TONE1_TIMING 171
 Cyclic Auto Resync 124

D

DATA_LINE_MODE 162
 Date and Time Settings 18
 DDI_ICD_GROUP_DISPLAY 165
 Default Gateway 68, 72
 Default Line for Outgoing 107
 DEFAULT_LANGUAGE 173
 DEFAULT_LINE_SELECT 161
 Detection Interval 80
 Detection Method 79
 DHCP Server 25, 145
 DHCP Settings 70
 Dial Plan 111, 214, 215
 Dial Plan (max 500 columns) 111
 Dial Plan Example 217
 Dial Plan Settings 215
 Dial Tone 117
 DIAL_PLAN_n 185
 DIAL_PLAN_NOT_MATCH_ENABLE_n 185
 DIAL_TONE1_FRQ 166
 DIAL_TONE1_GAIN 166
 DIAL_TONE1_TIMING 166
 DIAL_TONE2_FRQ 166
 DIAL_TONE2_GAIN 167
 DIAL_TONE2_TIMING 167
 DIAL_TONE4_FRQ 167

DIAL_TONE4_GAIN 167
 DIAL_TONE4_TIMING 167
 Direct Commands 48
 Directed Call Pickup 108
 DISCONNECTION_MODE 164
 Display Name 109
 DISPLAY_DATE_PATTERN 173
 DISPLAY_NAME_n 184
 DISPLAY_NAME_REPLACE 172
 DISPLAY_TIME_PATTERN 173
 DNS 92
 DNS Server 71
 DNS1 68, 72
 DNS2 68, 72
 Do Not Disturb 113, 114, 115
 Domain Name Server 71
 Downloading a Configuration File via the Web User Interface 28
 DSCP_RTCP_n 178
 DSCP_RTP_n 178
 DSCP_SIP_n 193
 DTMF 102
 DTMF Relay 102
 DTMF Type 102
 DTMF_INTDIGIT_TIM 184
 DTMF_RELAY_n 183
 DTMF_SIGNAL_LEN 184

E

Editing XML Configuration Files on your PC 45
 Enable DNS SRV lookup 92
 Enable Firmware Update 121
 Enable Global IP Address Usage per Line 81
 Enable Provisioning 123
 Enable Proxy 78
 Enable Shared Call 110
 Enable SSAF (SIP Source Address Filter) 97
 Enable VLAN 75
 Encryption 32
 Encryption Key 32, 148, 149
 Entering Characters 65
 Ethernet Link Status (LAN Port) 67
 Ethernet Link Status (PC Port) 67
 Ethernet Port Settings 73, 129, 151
 Ethernet Settings 17
 External RTP Port 82

F

Factory Defaults 16, 48
 Feature Number for Voice Mail Access 212
 Firewall and Router Setup 18
 FIRM_FILE_PATH 144
 FIRM_UPGRADE_ENABLE 143
 FIRM_VERSION 143
 Firmware File URL 122
 Firmware Maintenance 121
 Firmware Update 121, 143, 220
 Firmware Update Settings 128, 143, 220
 Firmware Update Using the SD Card 222
 Firmware Update, Executing 221
 Firmware Version 66

FIRSTDIGIT_TIM 160
 Flash Hook Event 108
 Flash/Recall Button 107
 FLASH_RECALL_TERMINATE 187
 FLASHHOOK_CONTENT_TYPE 188
 FLEX_BUTTON_FACILITY_ACTx 175
 FLEX_BUTTON_FACILITY_ARGx 175
 FLEX_BUTTON_LABELx 176
 Flexible Button Settings 131, 175
 Flexible Buttons 212
 FWD_DND_SYNCHRO_ENABLE_n 186

G

G722 (Enable) 103
 G722 (Priority) 103
 G729A (Enable) 104
 G729A (Priority) 104
 Global Address Detection 20, 79
 Global IP Address 81

H

Header Value for Resync Event 124
 HOLD_ALARM_FRQ 170
 HOLD_ALARM_GAIN 170
 HOLD_ALARM_TIMING 170
 HOLD_PACKAGE 162
 HOLD_RECALL_TIM 163
 HOLD_TONE_FRQ 171
 HOLD_TONE_GAIN 171
 HOLD_TONE_TIMING 172
 Host Name 70
 HTTP Authentication 78
 HTTP Client Settings 77
 HTTP Settings 129, 154
 HTTP User Agent 77
 HTTP Version 77
 HTTP_SSL_VERIFY 156
 HTTP_USER_AGENT 155
 HTTP_VER 155
 HTTPD_PORTOPEN_AUTO 154

I

Incorrect Example 139
 Initial Delay 102
 INTDIGIT_TIM 160
 Inter-digit Timeout 106
 International Call Prefix 106
 INTERNATIONAL_ACCESS_CODE 161
 IP Address 67
 IP Phone (Priority) 76
 IP Phone (VLAN ID) 75

J

Jitter Buffer 101

K

Keep Alive Interval 96
 KEY_PAD_TONE 165

L

LAN Port 73
Language 83
Language Selection 16, 22, 61, 82
Language Selection for the Unit 16
Line 1–Line 6 81
Line No. 69
Line Settings 132, 184
LINE_ENABLE_n 189
Link Speed/Duplex Mode 73
LLDP 74
LLDP Settings 74
LLDP_ENABLE 151
LLDP_INTERVAL 152
LLDP_VLAN_ID_PC 152
LLDP_VLAN_PRI_PC 152
LLDP-MED Interval timer 74
Loading Settings Using the SD card 45
Login Account Settings 128, 140
LOGO_URI_PHONE 175

M

MAC Address 67
MACRODIGIT_TIM 160
Maintenance 60
Maintenance Tab 60, 121
Master Configuration File 28, 124, 147
Master File URL 124
MAX_DELAY_n 179
Maximum Delay 101
Maximum RTP Port Number 99
MIN_DELAY_n 179
Minimum Delay 101
Minimum RTP Port Number 98
Miscellaneous Network Settings 129, 158
Miscellaneous VoIP Settings 132, 182
Model 66

N

NAPT 80
NAT 19, 80, 96, 201
NAT Identity 96
NAT Traversal 19, 81
National Access Code 107
NATIONAL_ACCESS_CODE 161
Network 53
Network Settings 16, 129, 151
Network Status 66, 67, 235
Network Tab 53, 69
New Password 84, 85
No Answer (Enable Call Forward) 115
No Answer (Phone Number) 116
No Answer (Ring Count) 116
NOM_DELAY_n 180
NOTES 2
NTP Server Settings 18
NTP_ADDR 157
NUM_PLAN_PICKUP_DIRECT 162
Number Matching Lower Digit 120
Number Matching Upper Digit 121
NUMBER_MATCHING_LOWER_DIGIT 172

NUMBER_MATCHING_UPPER_DIGIT 172
NW_SETTING_ENABLE 158

O

One-touch Buttons 212
ONHOOK_TRANSFER_ENABLE 164
Opening/Closing the Web Port 62
OPTION66_ENABLE 144
OS Version 66
Other Network Settings 18
OUTBANDDTMF_n 182
Outbound Proxy Server 91
Outbound Proxy Server Address 91
Outbound Proxy Server Port 91
Overview of Programming 22

P

PC (Priority) 75, 76
PC (VLAN ID) 75, 76
PC Port 74
PCMA (Enable) 104
PCMA (Priority) 104
PCMU (Enable) 104
PCMU (Priority) 105
Phone Number 69, 89
Phone User Interface Administrator Menu 49
Phone User Interface Programming 22, 48
PHONE_NUMBER_n 189
Port Close Timer 87
Port Forwarding 19
PORT_PUNCH_INTVL_n 201
POUND_KEY_DELIMITER_ENABLE 174
Pre-provisioning 25
Presence Server Address 90
Presence Server Port 90
Primary DNS Server 68, 71, 72
Priority of Setting Methods 46
Product Configuration File 28, 123, 146
Product File URL 123
PROFILE_ENABLE_n 190
PROVISION_ENABLE 145
Provisioning 27
Provisioning Maintenance 28, 122, 123
Provisioning Server 27, 31
Provisioning Settings 28, 128, 144
Proxy Server Address 79, 90
Proxy Server Port 79, 90
Proxy Server Settings 78

Q

Quality of Service (QoS) 95, 100

R

Recommended Environment 61
REDIALKEY_CALLLOG_ENABLE 164
Refresh Button 65, 67, 68
REG_EXPIRE_TIME_n 192
REG_INTERVAL_RATE_n 193
REG_RTX_INTVL_n 203
Registering Flexible Buttons 212

- Registering One-touch Buttons and BLF Buttons 212
 - Registrar Server Address 89
 - Registrar Server Port 89
 - Related Documentation 2
 - Reliability of Provisional Responses 96, 198
 - Reorder Tone 120
 - REORDER_TONE_FRQ 169
 - REORDER_TONE_GAIN 169
 - REORDER_TONE_TIMING 169
 - Reset 228
 - Reset to Defaults 125
 - Reset Web ID/Password 48, 63
 - Reset Web Settings 228
 - Reset Web Settings Button 125
 - Resource List URI 111
 - RESOURCELIST_URI_n 187
 - Restart 125
 - Restart Button 125
 - Result Messages 126
 - Resync Interval 124
 - RFC2543_HOLD_ENABLE_n 183
 - RINGBACK_TONE_FRQ 169
 - RINGBACK_TONE_GAIN 170
 - RINGBACK_TONE_TIMING 170
 - Ringing Tone 118
 - RINGING_OFF_SETTING_ENABLE 163
 - Root Certificate 156
 - Router Setup 20
 - RTCP Enable 101
 - RTCP Interval 101
 - RTCP Packet QoS (DSCP) 100
 - RTCP_ENABLE_n 181
 - RTCP_INTVL_n 179
 - RTCP_SEND_BY_SDP_n 182
 - RTP (Real-time Transport Protocol) Setup 20
 - RTP Packet QoS (DSCP) 100
 - RTP Packet Time 98
 - RTP Settings 20, 98, 132, 178
 - RTP_CLOSE_ENABLE_n 182
 - RTP_PORT_MAX 180
 - RTP_PORT_MIN 180
 - RTP_PTIME 181
- S**
- Save Button 65, 126
 - SDP_USER_ID_n 204
 - Secondary DNS Server 68, 71, 72
 - Security 97
 - Send SUBSCRIBE to Voice Mail Server 105
 - Service Domain 91
 - Setting Priority 46
 - SHARED_CALL_ENABLE_n 186
 - SIP Authentication 92
 - SIP extensions 96
 - SIP Packet QoS (DSCP) 95
 - SIP Server 89
 - SIP Service Domain 91
 - SIP Setting 88
 - SIP Settings 19, 87, 88, 133, 188
 - SIP Settings [Line 1]–[Line 6] 88
 - SIP Setup 19
 - SIP Source Address Filter (SSAF) 97, 206
 - SIP Source Port 91
 - SIP URI 89
 - SIP User Agent 88
 - SIP_100REL_ENABLE_n 198
 - SIP_18X_RTX_INTVL_n 199
 - SIP_2NDPROXY_ADDR_n 194
 - SIP_2NDPROXY_PORT_n 194
 - SIP_2NDPRSN_C_ADDR_n 200
 - SIP_2NDPRSN_C_PORT_n 200
 - SIP_2NDRGSTR_ADDR_n 194
 - SIP_2NDRGSTR_PORT_n 195
 - SIP_ADD_DIVERSION_n 209
 - SIP_ADD_RPORT_n 201
 - SIP_ANM_DISPNAME_n 205
 - SIP_ANM_HOSTNAME_n 206
 - SIP_ANM_USERNAME_n 205
 - SIP_AUTHID_n 190
 - SIP_CONTACT_ON_ACK_n 207
 - SIP_DETECT_SSAF_n 206
 - SIP_DNSSRV_ENA_n 197
 - SIP_FOVR_MAX_n 196
 - SIP_FOVR_NORSP_n 196
 - SIP_HOLD_HOLDRECEIVE_n 209
 - SIP_INVITE_EXPIRE_n 198
 - SIP_OUTPROXY_ADDR_n 204
 - SIP_OUTPROXY_PORT_n 205
 - SIP_P_PREFERRED_ID_n 203
 - SIP_PASS_n 190
 - SIP_PRIVACY_n 203
 - SIP_PRSN_C_ADDR_n 199
 - SIP_PRSN_C_PORT_n 199
 - SIP_PRXY_ADDR_n 191
 - SIP_PRXY_PORT_n 191
 - SIP_RCV_DET_HEADER_n 206
 - SIP_REFRESHER_n 197
 - SIP_REQUIRE_PORT_n 201
 - SIP_RESPONSE_CODE_CALL_REJECT 210
 - SIP_RESPONSE_CODE_DND 210
 - SIP_RGSTR_ADDR_n 191
 - SIP_RGSTR_PORT_n 192
 - SIP_SESSION_METHOD_n 193
 - SIP_SESSION_TIME_n 193
 - SIP_SRC_PORT_n 191
 - SIP_SUBS_EXPIRE_n 202
 - SIP_SVCDOMAIN_n 192
 - SIP_TCP_SRV_PREFIX_n 198
 - SIP_TIMER_B_n 207
 - SIP_TIMER_D_n 207
 - SIP_TIMER_F_n 208
 - SIP_TIMER_H_n 208
 - SIP_TIMER_J_n 208
 - SIP_TIMER_T1_n 195
 - SIP_TIMER_T2_n 195
 - SIP_TIMER_T4_n 196
 - SIP_TRANSPORT_n 205
 - SIP_UDP_SRV_PREFIX_n 197
 - SIP_URI_n 189
 - SIP_USER_AGENT 188
 - Source Port 91
 - SRV lookup Prefix for TCP 93
 - SRV lookup Prefix for UDP 93
 - SSAF → SIP Source Address Filter 97, 206
 - Standard Configuration File 28, 123, 145

Index

Standard File URL 123
Static IP Address 71
Static NAPT Settings 80
Static Settings 71
Statistical Information 101
Status 52
Status Tab 52, 66
STUN Server 80, 157
STUN Server Address 80
STUN Server Port 80
STUN Settings 129, 157
STUN_2NDSERV_ADDR 158
STUN_2NDSERV_PORT 158
STUN_SERV_ADDR 157
STUN_SERV_PORT 158
Stutter Tone 119
SUB_INTERVAL_RATE_n 204
SUB_RTX_INTVL_n 202
Subnet Mask 67, 72
Supports 100rel (RFC 3262) 96
Supports RFC 2543 (c=0.0.0.0) 103
Supports Rport (RFC 3581) 97
Supports Session Timer (RFC 4028) 96
Synchronize Do Not Disturb and Call Forward 110
Syslog Settings 128, 143, 235
SYSLOG_ADDR 143
SYSLOG_PORT 143
System 54
System Settings 128, 140
System Tab 54, 82
System Time Settings 128, 141

T

T1 Timer 94
T2 Timer 94
TALK_PACKAGE 162
Telephone 58
Telephone Settings 120, 129, 131, 159, 172
Telephone Tab 58, 105
Telephone-event Payload Type 99
TELEVENT_PAYLOAD 183
Terminal Number Settings 48
TFTP Server 25, 145
Time Adjust Settings 129, 157
TIME_QUERY_INTVL 157
TIME_SYNC_INTVL 157
TIME_ZONE_COUNTRY 141
Timer B 94
Timer D 95
Timer F 95
Timer for Dial Plan 106
Timer H 95
Timer J 95
Timer Settings 94
Timing of Downloading 29
Tone Frequencies 117, 118, 119, 120
Tone Settings 117, 130, 166
Tone Timings 117, 118, 119, 120
TONE_LEN_DISCONNECT_HANDSET 164
TONE_LEN_DISCONNECT_HANDSFREE 165
Trademarks 2
Transferring Encrypted Configuration Files 32

Transport Protocol 93
Transport Protocol for SIP 93
Troubleshooting 231

U

Unconditional (Enable Call Forward) 113
Unconditional (Phone Number) 114
USE_DEL_REG_CLOSE_n 200
USE_DEL_REG_OPEN_n 200
USER_ID 140
USER_PASS 140
Using 3 Types of Configuration Files 28

V

Version Information 66
VLAN Settings 75
VLAN_ENABLE 152
VLAN_ID_IP_PHONE 153
VLAN_ID_PC 154
VLAN_PRI_IP_PHONE 153
VLAN_PRI_PC 154
VM_NUMBER_n 184
VM_SUBSCRIBE_ENABLE 159
Voice Mail Access Number 109
Voice Mail Access, Feature Number 212
VOICE_MESSAGE_AVAILABLE 188
VoIP 55
VoIP Settings 98, 100, 132, 176
VoIP Settings [Line 1]–[Line 6] 100
VoIP Status 68, 69, 235
VoIP Tab 55, 87

W

WALLPAPER_URI_HOME 174
WALLPAPER_URI_PHONE 174
Web Language 61, 82, 83
Web Port 62, 64, 86, 87
Web Port Close Button 62, 64
Web Server Port 86
Web Server Settings 86
Web User Interface Programming 23, 51
Web User Interface Setting List 52
Web User Interface Window 64

X

XML Element/Attribute Configuration Parameter Table 35
XML Provisioning 32
XML Structure 33

Panasonic Corporation

1006, Oaza Kadoma, Kadoma-shi, Osaka 571-8501, Japan

© Panasonic Corporation 2011

PNQX3531VA DD1011MH4037